

Spirit GX

User Manual





Dear Sir / Madam,

Thank you for choosing GCC and the LaserPro Spirit GX. You can be assured that this machine meets the highest safety standards while using technological innovations shared by no other laser engraver. The Spirit GX is backed by GCC, a truly international company that is dedicated to help your business grow.

We at GCC are proud to introduce the LaserPro Spirit GX, our most technologically advanced laser engraver to date. This easy to operate machine has been designed with quality, productivity, and safety in mind. With innovations like the QSM™, stellar quality under high speed, SmartFILE file management, and the new DuraGuide, Enclosed Linear Low Maintenance Motion System, the Spirit GX is clearly on the cutting edge of all laser systems.

GCC understands that a creative technical background is the key to successful growth in the ever-changing information economy. We have a strong team of R&D experts who propel our company to new heights. From product development to manufacturing, our engineers are dedicated to innovation and quality.

Guiding our solid technical base is a world-class management team. At GCC, our leaders bring together marketing, technical support, research development and distribution experts to create an international network to meet your demands. Over the years, this network has been able to span throughout the globe. Our technical support staff is committed to provide you with impeccable service, and when your business is ready to grow, our team will be there!

Sincerely,

A handwritten signature in black ink, appearing to be 'L. Shih'.

Leonard Shih
President of GCC.



Table of Contents

Chapter 1	7
Safety	7
1.1 Principles of a CO2 Laser	8
1.2 Safety Ratings	8
1.3 The Safety Interlock System	8
1.4 Safety Labels	8
1.5 Safety Measures	14
1.6 Operating Environment	15
Chapter 2	17
Unpacking & Contents	17
2.1 Unloading and Unpacking	18
2.2 Contents and Accessories Checklist	21
Chapter 3	22
Mechanical Overview	22
3.1 Front View	24
3.2 Top View	24
3.3 Right (Profile) View	25
3.4 Left (Profile) View	25
3.5 Rear View	26
Chapter 4	27
Setup and Installation	27
4.1 Machine Setup	28
4.1.1 Powering Up the Machine	28
4.1.2 Power Cable Connection	28
4.1.3 Connecting the Computer	32
4.2 Graphics Software Setup	32
4.2.1 Recommended Computer Configuration	32
4.2.2 Installation of the LaserPro Print Driver	33
Chapter 5	34
Operating the LaserPro Spirit GX	34
5.1 Using the Hardware	35
5.1.1 Adjusting the LCD Display Screen's Contrast Setting	35
5.1.2 Graphic Control Panel Overview	35
5.1.3 Graphic Control Panel Navigation Chart	38
5.2 The LaserPro Spirit GX Print Driver	67
5.2.1 Page Setup and Orientation	67
5.2.2 Color Management	69
5.2.3 Using the LaserPro Spirit GX Print Driver	70
Chapter 6	93
Engraving and Cutting Techniques	93
6.1 Raster Engraving	94
6.2 Vector Cutting	94
6.3 Vector and Raster	95
6.4 3D Tips	96
Chapter 7	97
Optional Items	97
7.1 Air Extraction System Option	98
7.2 Air Compressor Optional Item	99
7.3 SmartBOX Option	102
7.4 SmartMEMORY Module Option ⁵	104

7.5 Rotary Attachment Option	106
7.6 SmartGUARD fire alarm Option	108
Chapter 8	112
Basic Maintenance	112
8.1 Suggested Cleaning and Maintenance Supplies	113
8.2 Maintaining the Work table and Motion System	113
8.2.1 Accessing the Work Table and Motion System.....	113
8.2.2 Cleaning the Work Table and Motion System	115
8.2.3 Lubrication of the Y Rails.....	115
8.3 Cleaning the Optics System.....	116
8.3.1 Removing the Mirrors	116
8.3.3 Removing and Cleaning the Focal Lens	119
Chapter 9.....	120
Basic Troubleshooting	120
Chapter 10.....	122
Appendix	122
10.1 Glossary	123
10.2 LaserPro Spirit GX Specification Sheet.....	124

1

Chapter 1

Safety

Principles of a CO₂ Laser

Safety Ratings

The Safety Interlock System

Safety Labels

Safety Measures

Operating Environment

1.1 Principles of a CO₂ Laser

LASER is the acronym for Light Amplification by Stimulated Emission of Radiation. A CO₂ laser works by electrically stimulating the molecules within a carbon dioxide gas mixture. When focused through a lens, this highly-intense and invisible beam will vaporize many materials. Depending on the speed and intensity of the projected beam, a CO₂ laser may be used to engrave or cut through a wide variety of materials.

1.2 Safety Ratings

The LaserPro Spirit GX is equipped with a sealed carbon-dioxide laser that emits intense and invisible laser radiation with a wavelength of 10.6 microns in the infrared spectrum. The laser system is designated as a Class I laser device, meaning that the system is equipped with key safety features and an enclosed laser head to completely contain the laser under normal use. One of the key safety features found on the LaserPro Spirit GX is a Class 3R red dot safety guidance pointer (similar to a laser-pointer presentation pen) allowing the operator to see the exact location where the laser beam will fire. Even though the LaserPro Spirit GX is equipped with the most powerful laser to date, through proper usage and taking necessary hardware safeguards, will make it an extremely safe machine. When the front door and back door are open, machine becomes a Class 4 equipment and users must wear goggles to operate the machine.

1.3 The Safety Interlock System

The laser system is equipped with a safety interlock system utilizing magnetic sensors on the top and side access doors, laser-activation and door LED lights on the control panel. The magnetic sensors will deactivate the laser when either door is opened. At this time, the “door” LED light found on the control panel will illuminate, indicating an open or improperly closed door. When the laser is in operation, the “laser” LED will illuminate to inform the operator that the laser is activated. If at any time, any of the access doors are open and the “laser” LED is illuminated, IMMEDIATELY unplug the laser system and contact GCC service team for technical support and maintenance instructions.

WARNING

- DO NOT operate the laser system if any component of the safety system is malfunctioning.
- DO NOT attempt to remove or modify any component of the safety interlock system.

1.4 Safety Labels

According to CDRH standards, all fixed or removable covers that allow access to a laser beam must have the appropriate laser warning labels attached to them. These warning labels must be clearly visible to the operator prior to removing the cover. Additional labels must be applied to the interior of the machine and be visible in the event when the covers are removed. A label clearly displaying the manufacturer’s name, date of manufacture, description of product, model number, serial number, and compliance statement must be attached to the outer surface of the machine.

In compliance with CDRH standards, the required warning labels are affixed at the time of manufacture to the LaserPro Spirit GX, attached on appropriate locations. These labels are not to be modified in any way or removed for any reason. Please familiarize yourself with the specific labels and their locations on the machine. Below is a list of all the safety labels and their locations on the machine.

Product Label

This label is located at the right-back side of machine. All the product information such as Serial Number, Model Numbers, Laser Power and Electric power can be found here. Before requiring any further tech support, always provide the service person with the information on this label.

		Serial Number 150357
Manufacturer		www.GCCworld.com
Product	Laser Engraver	
Model	Spirit GX	
Model Number	SGX - 30V	
Wavelength	10.57~10.63 μm	
Power	CO ₂ 30W	
Input	100~240V, 50~60Hz, Max 10A	
Manufactured	May 2012	
Class 3R Laser Product This product complies with EN60204-1:2006 Made in Taiwan 4F., No.236, Fude 2nd Rd., Xizhi Dist., New Taipei City 22151, Taiwan		
		

		Serial Number 150357
Manufacturer		www.GCCworld.com
Product	Laser Engraver	
Model	Spirit GX	
Model Number	SGX - 40C	
Wavelength	10.57~10.63 μm	
Power	CO ₂ 40W	
Input	100~240V, 50~60Hz, Max 12A	
Manufactured	May 2012	
Class 3R Laser Product This product complies with EN60204-1:2006 Made in Taiwan 4F., No.236, Fude 2nd Rd., Xizhi Dist., New Taipei City 22151, Taiwan		
		

		Serial Number 150357
Manufacturer		www.GCCworld.com
Product	Laser Engraver	
Model	Spirit GX	
Model Number	SGX - 40V	
Wavelength	10.57~10.63 μm	
Power	CO ₂ 40W	
Input	100~240V, 50~60Hz, Max 12A	
Manufactured	May 2012	
Class 3R Laser Product This product complies with EN60204-1:2006 Made in Taiwan 4F., No.236, Fude 2nd Rd., Xizhi Dist., New Taipei City 22151, Taiwan		
		

GCC <i>LaserPro</i>		Serial Number 150357
Manufacturer	GCC <small>www.GCCworld.com</small>	
Product	Laser Engraver	
Model	Spirit GX	
ModelNumber	SGX - 60T	
Wavelength	10.57~10.63 μ m	
Power	CO ₂ 60W	
Input	200~240V, 50~60Hz, Max 15A	
Manufactured	May 2012	
Class 3R Laser Product This product complies with EN60204-1:2006 Made in Taiwan 4F., No.236, Fude 2nd Rd., Xizhi Dist., New Taipei City 22151, Taiwan		

GCC <i>LaserPro</i>		Serial Number 150357
Manufacturer	GCC <small>www.GCCworld.com</small>	
Product	Laser Engraver	
Model	Spirit GX	
ModelNumber	SGX - 100T	
Wavelength	10.57~10.63 μ m	
Power	CO ₂ 100W	
Input	100~240V, 50~60Hz, Max 20A	
Manufactured	May 2012	
Class 3R Laser Product This product complies with EN60204-1:2006 Made in Taiwan 4F., No.236, Fude 2nd Rd., Xizhi Dist., New Taipei City 22151, Taiwan		

CDRH Label

This label indicates the class level of CDRH.



Warning Label

Warning Label is written with all the necessary information to be aware of in every operation.

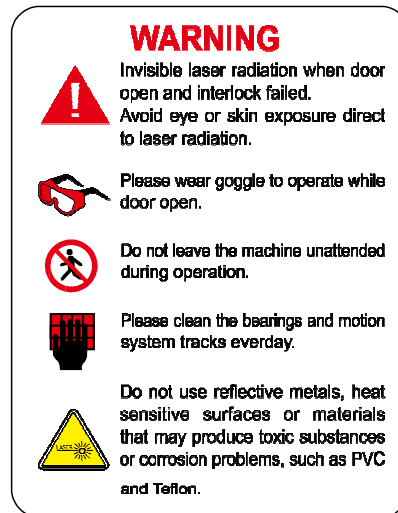

Laser Path Warning Label

LaserPro machines are very safe under normal functioning conditions. However, in case of any accident, Laser Path Warning Label will be affixed on the possible laser path. When operators are nearby these paths, they should be careful of the possible injury while the machine is operating.



Laser Path Danger label

This label indicates the laser path. Normally you can find this label inside of machine. Please take extra caution of this area when you conduct maintenance.

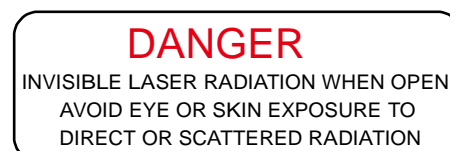

Aperture warning stickers (mirror):

This label indicates the laser path. Normally you can find this label inside of machine or laser exit. Please take extra caution of this area when you conduct maintenance or operate machine.

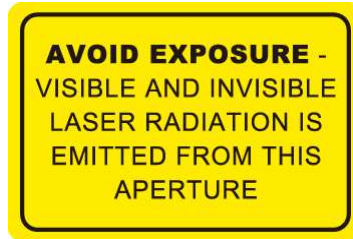

Laser Radiation Label Sticker

Caution: In this area pay attention to the possible dangers of the laser beam.



Door open warning labels



1.5 Safety Measures

- **LASER RADIATION WARNING:** Exposure to laser radiation may result in physical burns and severe eye damage. Proper use and regular maintenance of this machine is important to the safety of all people in the immediate area.
- Prior to operation, carefully read and familiarize yourself with the warning labels located on both your laser system and in this manual.
- Never leave the machine unattended during the laser cutting and engraving process. The laser may ignite combustible materials. A well-maintained fire extinguisher and operational smoke or fire detector should be kept in the vicinity of the machine.
- **Caution—Use of controls or adjustments or performance of procedures other than those specified herein may result in hazardous radiation exposure.**

NOTE

SmartGUARD™ is an optional fire detection alarm system developed by GCC. Contact your local GCC authorized distributor for more details to have this safety option installed onto your system.

- Enable the SmartAIR™ nozzle when engraving or cutting materials that may easily ignite, such as acrylic, wood, or paper.
- Always wear safety goggles when the laser system is in operation. Reflective materials such as mirrors, enameled brass and anodized aluminum may partially-reflect some of the invisible laser radiation. Severe eye damage may occur if proper safety goggles are not worn.

NOTE

Each LaserPro laser machine is shipped with a single pair of safety goggles. If additional safety goggles are required, please contact GCC directly or an authorized GCC distributor. If you wish to purchase one on your own, please make sure the safety goggles meet these requirements:

10,600 nm OD5+
Visible Light Transmission: 92.9%

- Connect the machine to a properly grounded power outlet. Ensure the voltage of the power source is identical to the voltage of the machine.
- Do not open the laser access panel when the machine is plugged in.
- Do not attempt to modify or disassemble the laser module.
- Do not attempt to remove or modify any component of the machine's laser interlock safety system.
- Ensure the immediate work area of the machine is well-ventilated. Odors, vapors, and dust are byproducts generated during the laser engraving and cutting process. An exhaust system, vacuum

cutting box, and honeycomb table are recommended. Please contact GCC or your local GCC distributor for more information.

- Do not laser heat-sensitive surfaces or materials that may generate toxic fumes, such as PVC and Teflon.

Regularly clean and maintain your machine according to our cleaning and maintenance instructions. Doing so will ensure your machine will operate effectively and safely over a long period of time.

1.6 Operating Environment

Please follow the guidelines when considering a suitable location to set the LaserPro Spirit GX. Improper work environments may lead to operational malfunction and/or unsafe working conditions. The LaserPro Spirit GX should be placed and operated in a standard office-type environment.

- Avoid environments where the machine is exposed to high levels of dust, temperature (temperatures exceeding 30°C or 85°F) or humidity (humidity exceeding 70% or where the ambient temperature is near the dew point).
- Avoid small, enclosed areas with poor ventilation.
- Avoid areas with high levels of noise and electrical noise.

- Select a location that is large enough to accommodate the LaserPro Spirit GX, an exhaust system, a computer and a work or storage table.
- Select a location in which the ambient temperature remains between 15°C and 30°C (60°F to 85°F).
- Select a location in which the relative humidity remains between 30% - 40%.
- Select a location in which there is a short, direct path to the fume exhaust system.
- Set the LaserPro Spirit GX on a floor surface that is completely even.
- Make sure your smoke or fire detection system in the immediate area is functioning.
- Setup the machine to be apart from the wall for at least 60 cm (2 feet).



2

Chapter 2

Unpacking & Contents

Unloading and Unpacking

Contents and Accessories Checklist

2.1 Unloading and Unpacking

The LaserPro Spirit GX is shipped in one crate that contains the machine, the software, and all of the necessary accessories. The following section shows detailed step-by-step instructions for unpacking and assembly of the machine.



WARNING

More than one person may be needed when loading and unloading the shipping crate in order to avoid body injury or damage to the machine.

NOTE

Please store the original shipping crate as it may be needed for transportation in the future.

Unpack via the following steps:

- 1) Move the shipping crate to the proximity of the designated work area.
- 2) Loosen the screws fastening the top board and remove the top board.
- 3) Loosen the screws fastening the sideboards for each side and remove each sideboard.

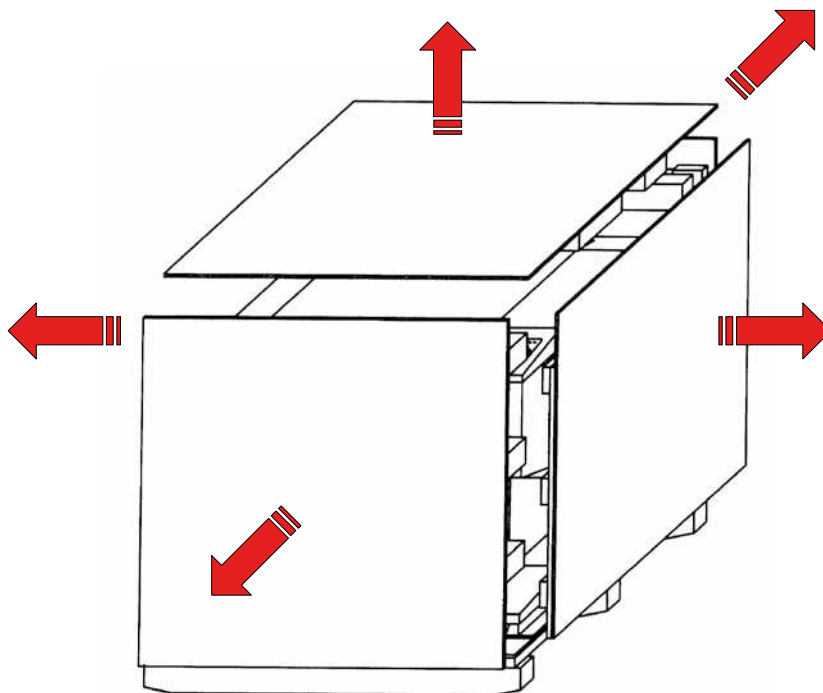

- 4) Unfasten and remove the two safety harnesses via the safety belt buckles on the front side.

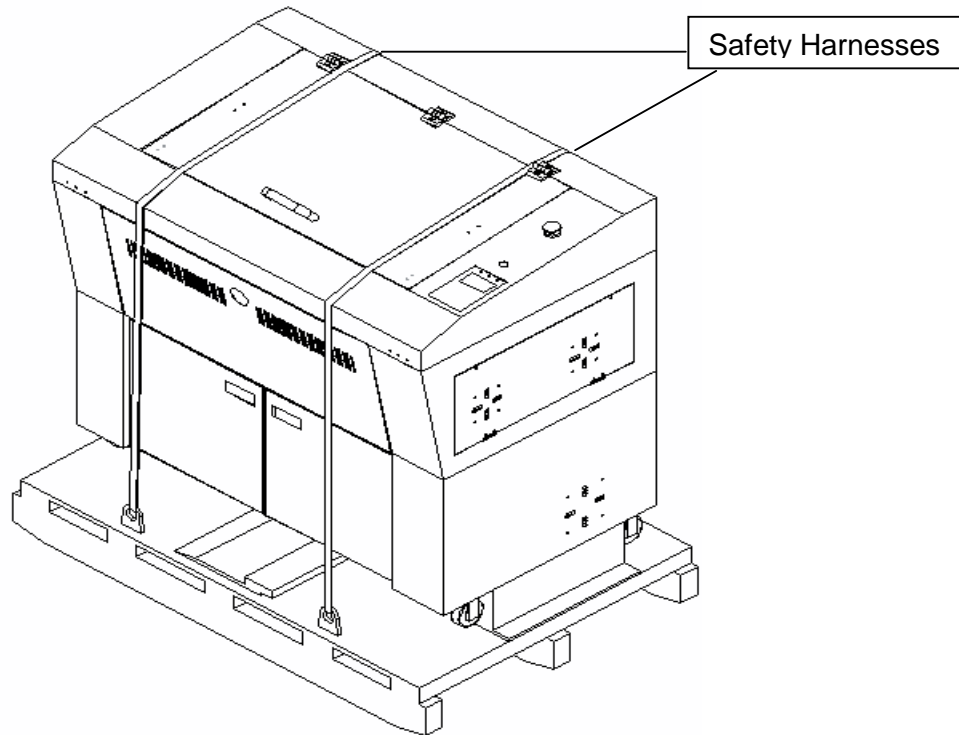

- 5) Remove the screws holding the spacers (left and right sides of the machine) and the step board (front and rear of the machine). Remove the two spacers and the step board.

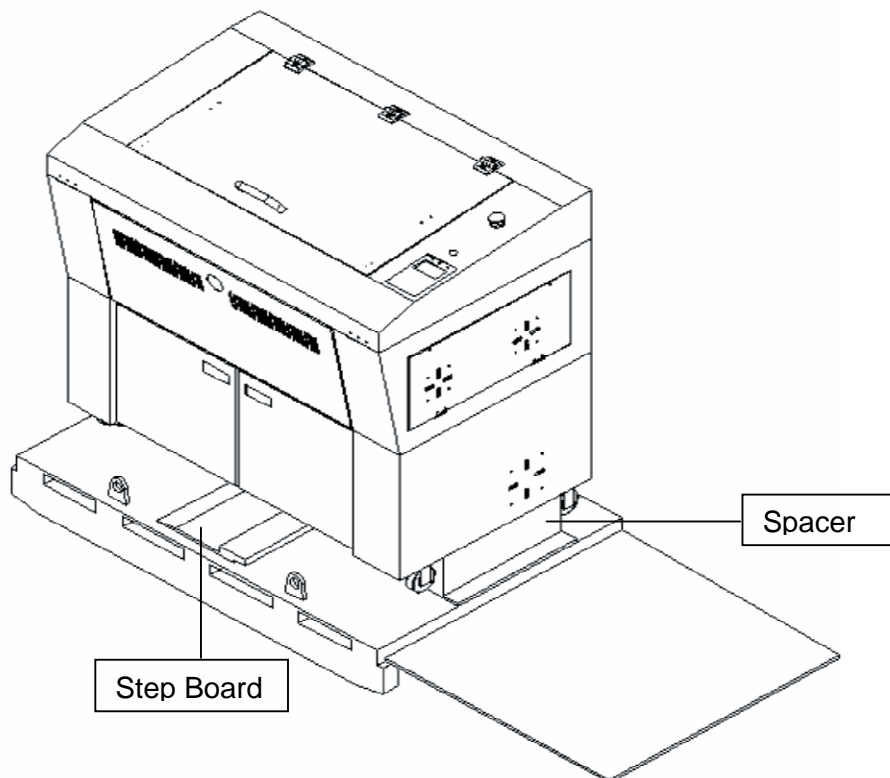

- 6) After removing the left and right sideboards, place one against the left or right side of the shipping crate. Place the step board against the inclined sideboard to form a ramp.

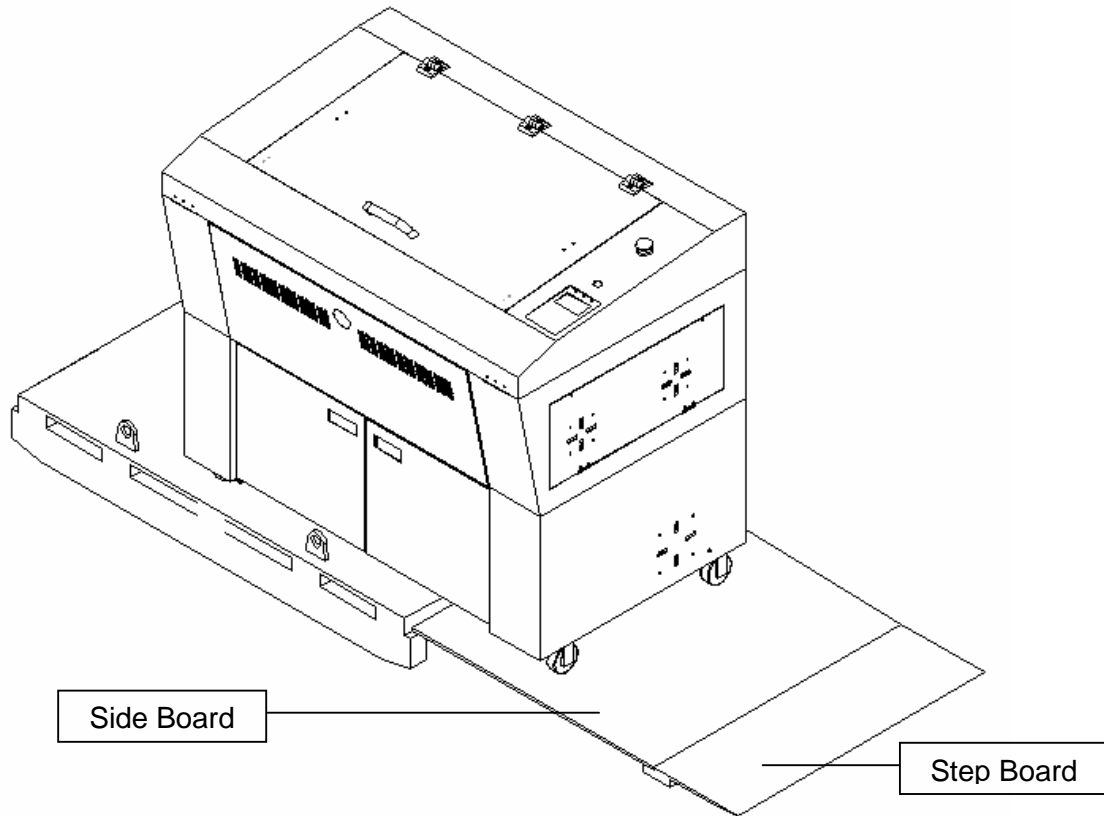

- 7) Gently push the machine off the shipping crate and relocate it to an appropriate work area.

2.2 Contents and Accessories Checklist

Please check to make sure that all of the following items are included within the shipping crate. If any of the following items are missing, immediately contact your local GCC distributor.

ITEM		QUANTITY
Cleaning Kit	Cotton	1
	Lens Cleaner Solution	1
	Lens Tissue	1
Power Cord (US/EU/AU)		2 / each
Printer Port Cable		1
USB Port Cable		1
Focusing Tool		1
CO ₂ #900 Goggles		1
Hose Connector		1
Installation CD (LaserPro Spirit GX user manual, driver, and firmware)		1
Pencil Sample		2
PS2 Lubrication Grease		1
Promise Card		1



3

Chapter 3

Mechanical Overview

Front View

Top View

Right (Profile) View

Left (Profile) View

Rear View

Please take some time to familiarize yourself with this section regarding the mechanical overview of the LaserPro Spirit GX. References will be made back to the different parts of the LaserPro Spirit GX in later sections.

3.1 Front View



3.2 Top View

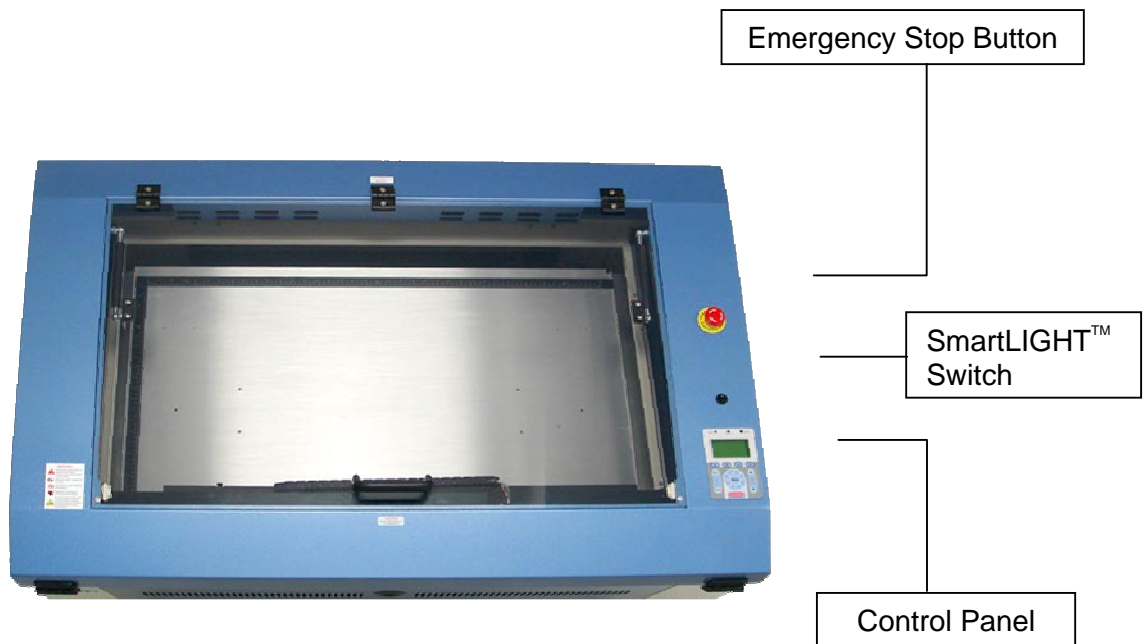

3.3 Right (Profile) View



3.4 Left (Profile) View



3.5 Rear View

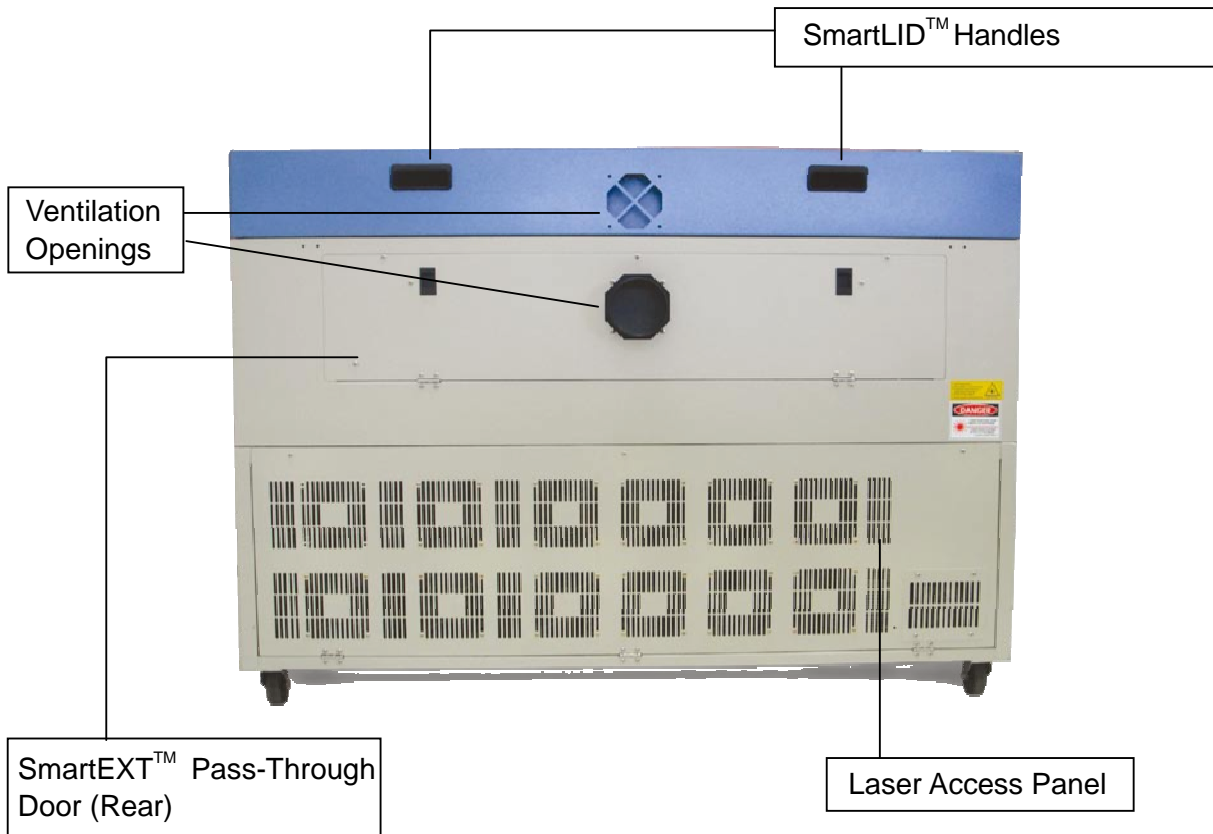

4

Chapter 4

Setup and Installation

Machine Setup

- Powering Up the Machine
- Power Cable Connection
- Connecting the Computer

Graphics Software Setup

- Recommended Computer Configuration
- Installation of the LaserPro USB Driver
- Installation of the LaserPro Print Driver

4.1 Machine Setup

4.1.1 Powering Up the Machine

⚠ CAUTION

Make sure both the LaserPro Spirit GX and the computer are turned off before connecting either to a power source.

- 1) Connect the male end of the power cord to a quality surge protector and then connect the surge protector to a properly grounded outlet.
- 2) Do the same for the computer system.
- 3) Connect the female end of the power cord into the machine's power cable inlet located on the right side of machine.

NOTE

- The LaserPro Spirit GX has been designed to automatically switch from 100~240 VAC.
- 220V is required for 40W and above LaserPro Spirit GX models

TIP: Please adjust the LCD Display Screen's Contrast before plugging in the Electrical cord for your laser. LCD adjustment wheel is in this location under lid.

4.1.2 Power Cable Connection

If the LaserPro Spirit GX you purchased is a 100W laser power, please have a professional technician install the power cable wiring as shown below.

Step 1 Each Spirit GX 100W machine is equipped with the following power cord which is marked separately with G-Ground, N-Neutral, and L-Live. Notice that the two ends of the power cord has different type of connectors, O-shape and Y-shape.

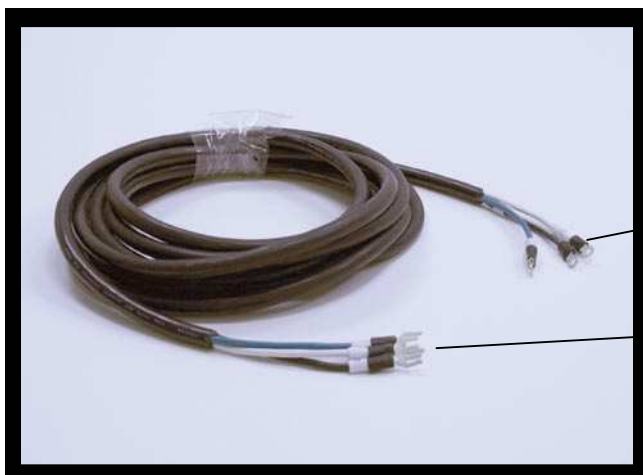

O shaped, connect to laser machine

Y shaped, connect to electricity outlet on the wall



Step 2 Unscrew the laser cabinet panel at the rear side of Spirit GX.

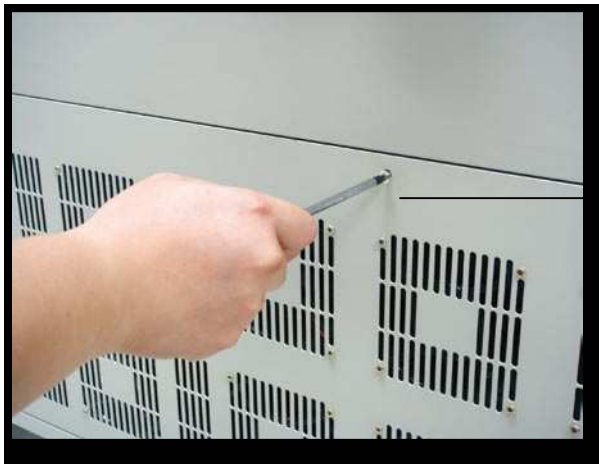

Unscrew the laser cabinet

Step 3 Unscrew the black fixing connector on the right-hand side of Spirit GX.



Black fixing connector



Loosen the fixing connector in the opening

Step 4 Insert the O-shaped power cord through the black wiring connector to form Assembly C.

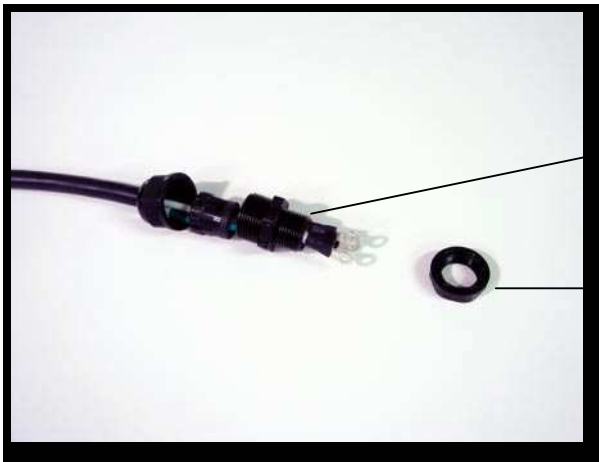

Assembly C

O-ring, B

Step 5 Install the Assembly C in step 4 to Spirit GX through an opening and use O-ring B to fix it.

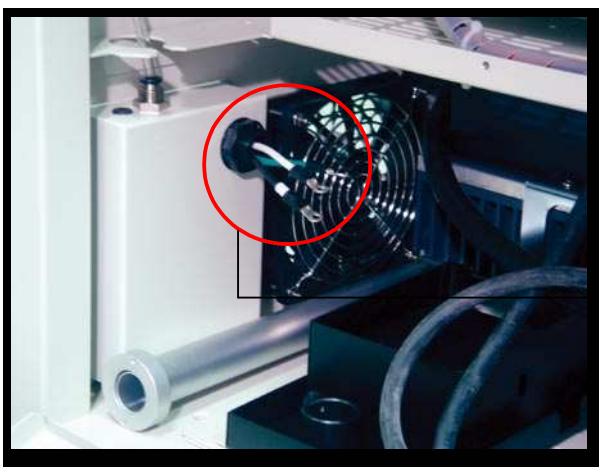

Install the assembly C (located outside of laser machine) and O-ring B (located inside of laser machine) to the machine

O-ring B to fix the wiring

Step 6 Loosen the screws on the terminal connector, affix the O-shaped power cord and re-install the screws to fasten the O-shaped power cord.



Install O-shaped power cord in order of L (white), G (green), and N (black) from left to right

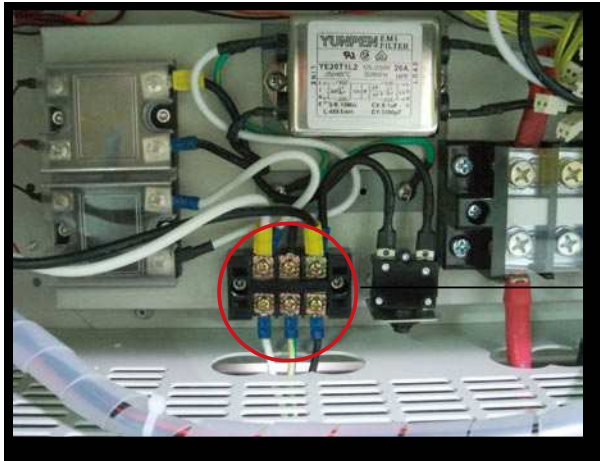

Use a screwdriver to fix the wiring

Step 7 Close the laser cabinet panel to finish the power cord installation.

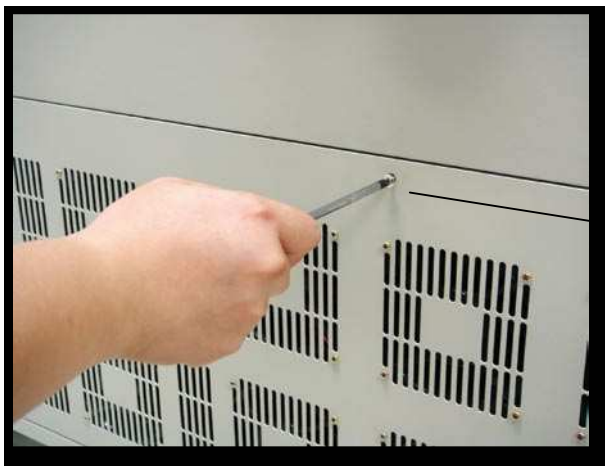

Screw the laser cabinet panel to finish the power cord installation

4.1.3 Connecting the Computer

The LaserPro Spirit GX can communicate with a computer through a USB Port or Parallel Printer Port connection interface. The USB Port connection offers faster file transfer and greater flexibility over the Parallel Printer Port connection. Regardless of the connection method chosen, you will need to connect the respective connection cable from the LaserPro Spirit GX to your computer.

USB Connectivity: Connect the included USB Port Cable to the USB Port on the right-hand side of the LaserPro Spirit GX.

Printer Port Connectivity: Connect the included Printer Port Cable to the Printer Port on the right-hand side of the LaserPro Spirit GX.

NOTE

If you have purchased additional Optional Accessories for the LaserPro Spirit GX, please refer to chapter VII for instructions on how to properly setup your optional accessories. These should be setup prior to working with your LaserPro Spirit GX.

4.2 Graphics Software Setup

The LaserPro Spirit GX is compatible with graphics software that can output HPGL commands, such as CorelDraw, Adobe Photoshop, AutoCAD, Illustrator etc.

Supported Graphic Software

- Photoshop, CorelDraw, Illustrator, AutoCAD

Other software such as Engrave Lab and PhotoGrav may work with the LaserPro Spirit GX, but LaserPro does not guarantee 100% compatibility and will not provide technical support for them.

NOTE

Technical support will not be offered, if you experience output problems with non-supported graphics software.

4.2.1 Recommended Computer Configuration

The LaserPro Spirit GX operates under Windows operating systems and is designed to work on a computer that meets the following minimum requirements.

Personal Computer

■ Hardware Compatibility

- CPU – Pentium 90 (or equivalent) or greater
- RAM – 32 MB or higher
- HDD – 1.2 GB Hard Drive or greater
- SVGA – 15" Super VGA Monitor
- On Board Parallel Mode (Enabled from motherboard's BIOS)
- SPP – Preferred Mode
- ECP – Cable (Less than 1.8 meters)

Software Compatibility

- The LaserPro Spirit GX drivers are designed for Windows 2000, XP, and above Windows operating systems.

4.2.2 Installation of the LaserPro Print Driver

- 1) Insert the LaserPro CD.
- 2) From the auto run menu, select Spirit GX-->LaserPro Driver to begin the LaserPro Print Driver installation.
- 3) When the Add Printer Wizard menu comes up, click Next to continue.
- 4) At the Local or Network Printer page, select <Local printer attached to this computer>, then click Next to continue.
- 5) At the Select a Printer Port page, select <Use the following port> and select the port that the LaserPro Spirit GX will be attached to, then click Next to continue.
- 6) The next screen will prompt you with a list to select the manufacturer and model of your printer. From this menu, click Have Disk. Another menu will now pop up for you to indicate the location of the print driver. With the LaserPro CD still in your drive, click Browse and point to the file located at: F:\Spirit GX\LaserPro driver\WIN XP\Dv3.45\GL345.inf (where F is the drive letter assigned to your CD-Rom drive) and click OPEN to have Spirit GX displayed as a valid printer.
- 7) Now select Spirit GX from the list of printers (Spirit GX should be the only printer displayed on the list) and click Next to continue.
- 8) If a screen comes up informing you of the detection of a previous driver and asks to keep the existing driver or use the new one, select <Replace Existing Driver> and click Next to continue.
- 9) This screen will prompt you to provide a printer name. Simply type in <Spirit GX> and select Yes or No if you want to use this printer as the default printer and click Next to continue.

NOTE

When working with the LaserPro Spirit GX Print Driver within your graphics software, you will need to have the Spirit GX set as the default printer to get proper output. If you select to not have the Spirit GX be the default printer, please remember to manually change this on your own from within the graphic software printer selection area or from the Windows Control Panel → Printers and Faxes section.

- 10) At the Printer Sharing screen, select <Do not share this printer> and click Next to continue.
- 11) Select <No> when asked if you want to print a test page and click Next to continue.
- 12) Now simply click Finish to complete the Add Printer Wizard.
- 13) Now the installation will proceed, if you get a Hardware Warning about the software you are installing for this hardware has not passed Windows Logo testing, simply click Continue Anyway to ignore this warning.
- 14) Congratulations, your printer driver has been successfully installed!
- 15) This step is required only for USB connections. If you are using the Spirit GX's USB connection interface, then you will need to go to your Windows – Control Panel – Printer and Faxes. Right-click on the Spirit GX listing, and select properties. Go to the Ports menu and place a check next to GCC USB0, then click OK.

5

Chapter 5

Operating the LaserPro Spirit GX

Using the Hardware

- Adjusting the LCD Display Screen's Contrast Setting
- Graphic Control Panel Overview (Description)
- Graphic Control Panel Navigation Chart
- Graphic Control Panel Function Pages

The LaserPro Spirit GX Print Driver

- Page Setup and Orientation
 - Color Management
 - Using the LaserPro Spirit GX Print Driver
 - LaserPro Spirit GX Print Driver >> Options Page
 - LaserPro Spirit GX Print Driver >> Pen Page
 - Spirit GX Print Driver >> Advanced Page
 - Spirit GX Print Driver >> Paper Page
 - Spirit GX Print Driver >> Language Page
-

Once you have installed the LaserPro USB Driver (for use with USB connection), LaserPro Print Driver, and have connected the LaserPro Spirit GX to your computer, you will need to familiarize yourself with the LaserPro Spirit GX's control panel and LaserPro Print Driver. The print driver will be where specific laser parameters for your jobs are configured, while the control panel will allow you to set repeat times, manipulate file order, perform auto / manual focusing, and more.

5.1 Using the Hardware

5.1.1 Adjusting the LCD Display Screen's Contrast Setting

Depending on the lighting of your immediate work area, you may need to adjust the contrast of LCD display screen. You may increase or decrease the display screen's contrast via the contrast adjustment wheel found on the inside of the front cover on the bottom, right-hand side. You can access this area by opening the top window and looking inside to the rear, right side of the work area (as shown in the picture below).

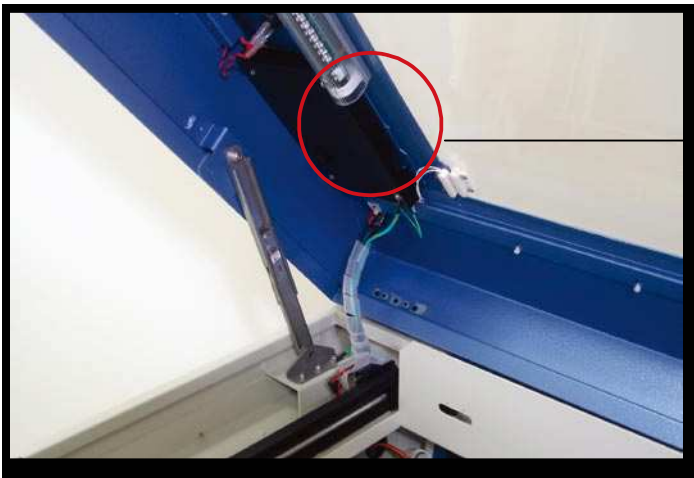

LCD Display Screen's Contrast Adjustment Wheel

5.1.2 Graphic Control Panel Overview

The Control Panel

The control panel on the LaserPro Spirit GX provides an easy access to all the manual controls needed for cutting and engraving. The liquid crystal display (LCD), functional, directional and selection buttons make navigating through the machine's manual controls easy to do.



LED Indicator Lights

LCD Display Screen

Function Buttons

Directional and Selection Buttons

LED Indicator Lights

Three indicator lights on the LaserPro Spirit GX's control panel are part of the system's safety interlock system.

- **Door** - The door light will illuminate when either the top lid or external pass through doors on the LaserPro Spirit GX are open or improperly closed.
- **Power** - The power light will illuminate when the LaserPro Spirit GX is powered on.
- **Laser** - The laser light will illuminate when the laser is active and in operation.

WARNING

- DO NOT attempt to remove or modify any component of the safety interlock system.
- If at any time, any of the access doors are open and the "laser" LED is illuminated, unplug the laser system IMMEDIATELY and contact GCC technical support for service instructions.
- DO NOT operate the laser system if any component of the safety system is malfunctioning.

NOTE

There is an 8 second warm up period after the door LED is triggered for systems equipped with Synrad laser tubes. i.e. opening the top lid or the external pass through doors of the machine. Operator must wait for 8 seconds before the laser tube can begin to work.

Directional and Selection Buttons

Function (F1 / F2 / F3 / F4) – Four function buttons allow you to select various functions which will change depending on what section of the menu you are in. Each function button's corresponding task will be displayed right above its respective button on the LCD display screen. Please note that in certain menus, not every function button will always be mapped to a corresponding action. In these situations, that particular button will not have a function.

Directional (Δ / ∇ / \triangleleft / \triangleright) – Four directional buttons allow you to navigate the selection cursor through the control panel menu and adjust the value of specific settings. In general, the Δ / ∇ directional buttons cycle through the various selections, while the \triangleleft / \triangleright directional buttons adjust the value of that particular selection.

Enter – Confirms the current selection.

Start / Stop – Allows you to start or stop engraving jobs, once those jobs have been successfully loaded onto the system.

Delete – Provides quick access to delete the current job.

Pause – Pauses the current engraving process. Press again to resume the current process.

Auto Focus – After you have positioned your material and moved the laser carriage head to the area you want to engrave, press this button and the system will automatically adjust the optimal vertical focal distance for the laser.

Manual Focus (\blacktriangle / \blacktriangledown) – To manually adjust the vertical focal distance between the laser head and the material, you can use the \blacktriangle / \blacktriangledown buttons to do so. Doing so will adjust the vertical height (z-axis) of the worktable.

5.1.3 Graphic Control Panel Navigation Chart

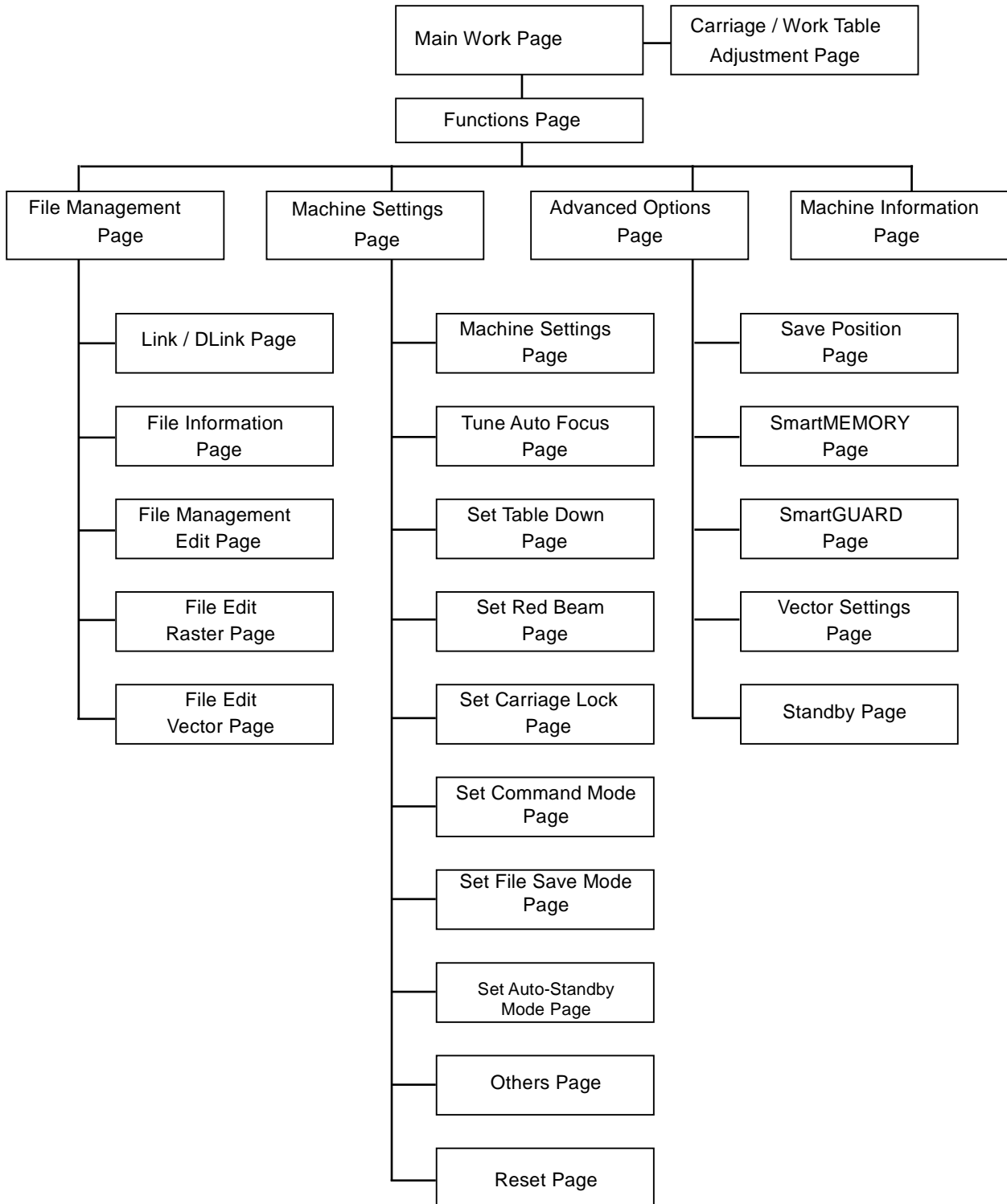

5.1.4 Graphic Control Panel Function Pages

When the LaserPro Spirit GX is powered on, the machine will perform a series of safety checks and initialization routines. The LCD display screen will display the GCC copyright, LaserPro logo, and machine initialization pages before going to the main work page.

Main Work Page

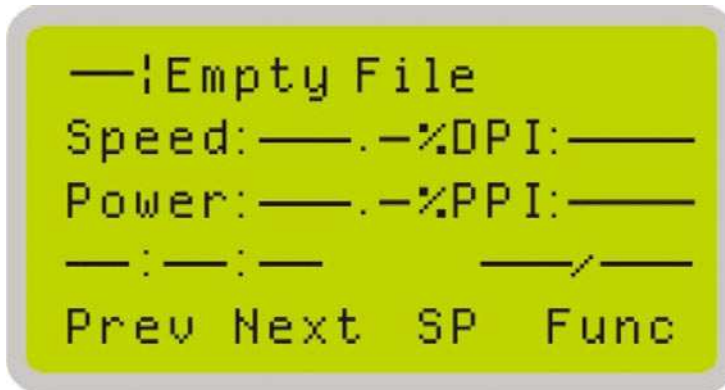

The main work page is the page that the LaserPro Spirit GX will default to upon startup and will be the “home base” for when navigating through the various functions of the control panel. This will be the page that is displayed when you are processing your jobs. This page contains specific job information such as the current job’s name, Speed, Power, PPI, DPI, processing / remaining times, and jobs loaded.

Note: When you select SmartCENTER from the driver “SP” option will be available on the main work page as shown in the above picture.
On the contrary, if you do not select SmartCENTER the “SP” will not be available on the screen.

Main Work Page	
Relevant Buttons	Function
F1 (Prev)	Scroll through previous jobs
F2 (Next)	Scroll through next jobs
F3 (SP)	Go to Store Position Page for SmartCENTER
F4 (Func)	Go to Functions Page
△ / ▽ / ◀ / ▶ Directional	Go to Carriage / Work Table Adjustment Page
Start / Stop	Start / Stop the current job
Delete	Delete the current selected job
Auto Focus	Initiate the auto focus function
▲ / ▼ Manual Focus Buttons	Manually adjust the height of the work table (Z-axis)

Carriage / Work Table Adjustment Page

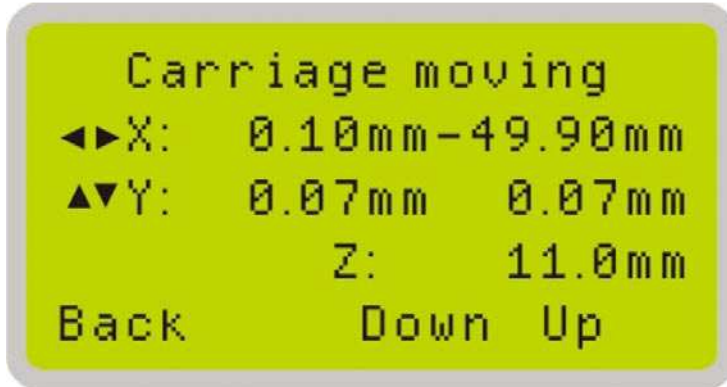

i Navigating to this page:

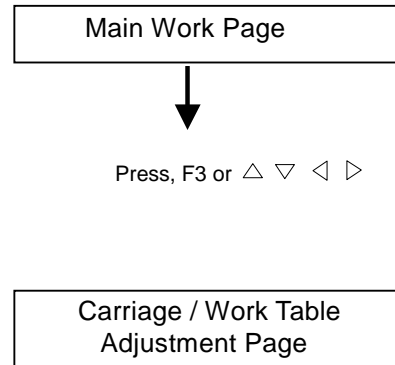

The Carriage / Work Table Adjustment Page allow you to manually increase and decrease the height of the work table (Z-axis). In addition, you can manually adjust the Y-axis and X-axis of the laser carriage.

Carriage / Work Table Adjustment Page	
Relevant Buttons	Function
F1 (Back)	Back to previous page
F3 (Down)	Manually decrease the height of the work table (Z-axis)
F4 (Up)	Manually increase the height of the work table (Z-axis)
△/▽ Directional	Manually adjust the Y-axis position of the laser carriage
Start / Stop	Back to main work page
Auto Focus	Initiate the auto focus function
▲ / ▼ Manual Focus Buttons	Manually adjust the height of the work table (Z-axis)

|

SmartCENTER Page

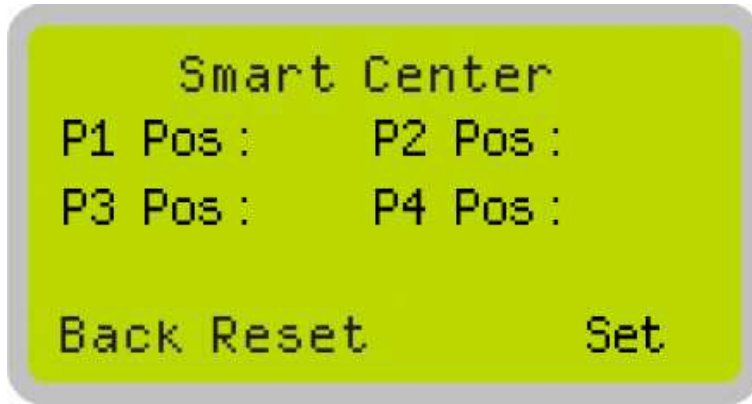

i Navigating to this page:

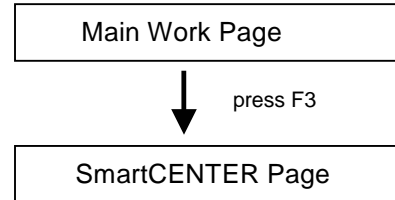

Under SmartCENTER mode the job will begin after the system positions the carriage to the center position between two or four points indicated by the user. The SmartCENTER mode has to be enabled through the driver.

Enter SmartCENTER page by pressing the F3 button. You will be prompted to indicate and store the position points. The positions can be indicated by moving the carriage by hand and pressing enter to save the positions indicated by the red pointer. After all points are set, the carriage will move to the center of the stored positions and the job will begin.

SmartCENTER Page	
Relevant Buttons	Function
F1 (Back)	Back to previous page
F2 (Reset)	Reset all saved positions
F4 (Save)	Save current lens carriage position
Auto Focus	Initiate the auto focus function
▲ / ▼ Manual Focus Buttons	Manually adjust the height of the work table (Z-axis)

Functions Page

The Functions Page allows you to edit file management and machine settings. From this page, you will be able to access the File Management, Machine Setting, and Machine Information pages.

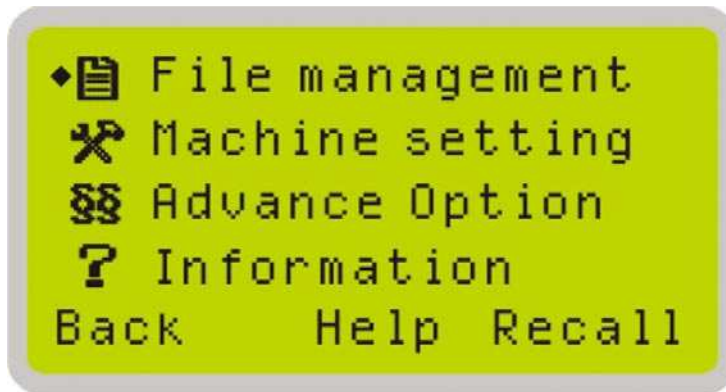

i Navigating to this page:

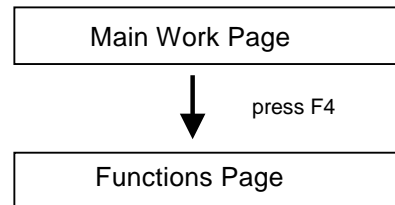

- File Management Page – this page allows you to manage the files that you have loaded onto the LaserPro Spirit GX.
- Machine Setting Page – this page allows you to access and modify various machine settings, including: Set Lens, Tune Auto Focus, Set Table Down, Set Red Beam, Carriage Lock, Set Command Mode, Save Position, Flash Memory, Set File Save Mode, Set Vector Mode, Tune Image Power, Set Laser Wattage, Set Fine Mode, Other, Reset.
- Machine Information Page – this page allows you to view information regarding the system such as the GCC logo, machine name, firmware version, and other information.

Functions Page	
Relevant Buttons	Function
F1 (Back)	Back to previous page
F3 (Help)	Display help
F4 (Recall)	Back to previous page
△ / ▽ Directional	Scroll through the menu selections
Enter	Perform the selection
Start / Stop	Back to Main Work Page
Auto Focus	Initiate the auto focus function
▲ / ▼ Manual Focus Buttons	Manually adjust the height of the work table (Z-axis)

File Management Page



i Navigating to this page:

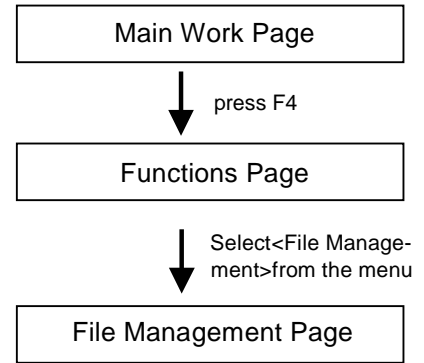

The File Management Page allows you to manage the files that you have loaded onto the LaserPro Spirit GX. You can scroll through your jobs, delete a selected job, delete all jobs, and go to the Link / DLink Page to set and arrange multiple loaded jobs into a single job queue for processing.

File Management Page	
Relevant Buttons	Function
F1 (Back)	Back to previous page
F2 (Link)	Go to the Link / DLink Page
F3 (D-All)	Delete all loaded jobs
F4 (Del)	Delete the selected job
△ / ▽ Directional	Scroll through your loaded jobs
Enter	Go to the File Information Page for the selected job
Start / Stop	Go to the Main Work Page for the selected job
Auto Focus	Initiate the auto focus function
▲ / ▼ Manual Focus Buttons	Manually adjust the height of the work table (Z-axis)

Link / DLink Page

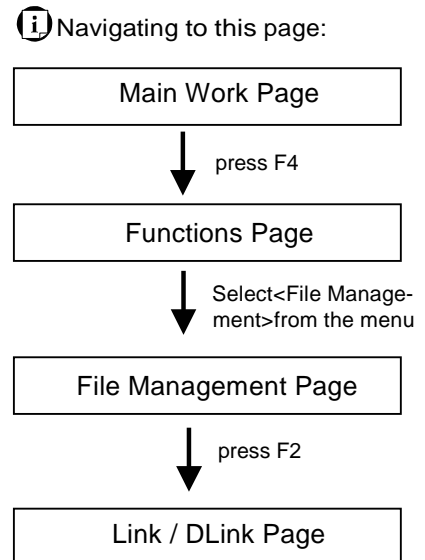
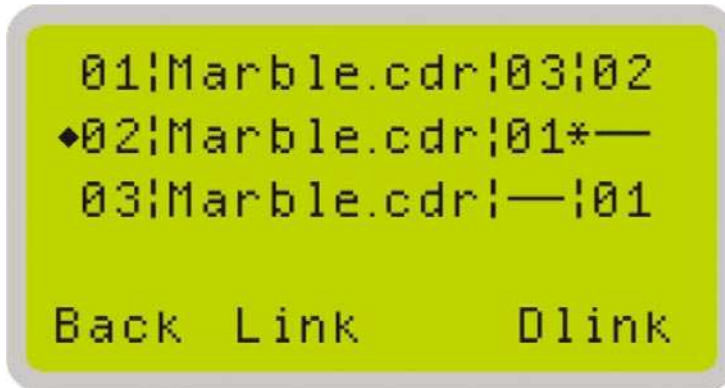

The Link / DLink Page allows you to set, arrange, and remove loaded jobs to and from a job queue for processing. Use the directional keys to cycle through your loaded jobs, then simply press the <F2 (Link)> key to add a file to the job queue. The job queue will be set in a sequential order based on the order you link the files. To remove a job from your job queue, press the <F4 (DLink)> key.

The first column field (before the file name) displays the job number. The sequence for your job queue is displayed in the two columns to the right of your file names. The first column to the right of your job file name displays the job number of the previous file in the job queue sequence. The second column after the file name displays that job's next file in the job queue sequence. First and last jobs in the job sequence you set will have a (---) in the first and second columns respectively. So according to the image above, the job queue sequence has been set to be processed in this order:

0 Marble.cdr → 01:Marble.cdr → 02:Marble.cdr.

Link / DLink Page	
Relevant Buttons	Function
F1 (Back)	Back to previous page
F2 (Link)	Add the currently-selected job to the job queue
F4 (DLink)	Remove the currently-selected job from the job queue
△ / ▽ Directional	Scroll through your loaded jobs
Start / Stop	Back to Main Work Page
Auto Focus	Initiate the auto focus function
▲ / ▼ Manual Focus Buttons	Manually adjust the height of the work table (Z-axis)

File Information Page

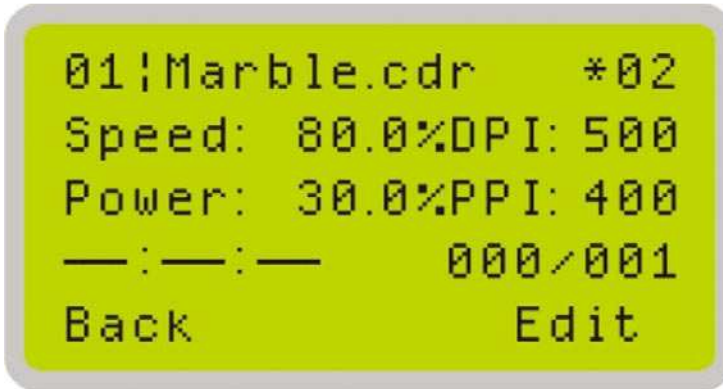

i Navigating to this page:

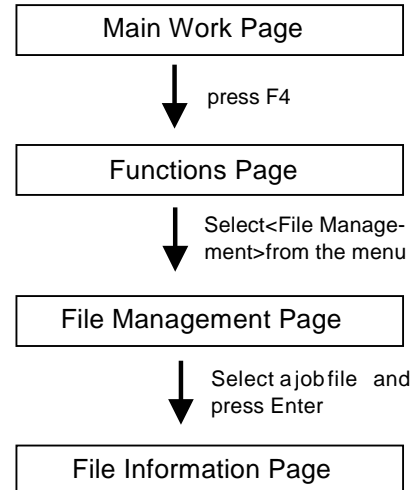

The File Information Page allows you to view the speed, power, DPI, and PPI settings of the selected job. In addition, you will be able to go to the File Management Edit Page from this menu to change raster / vector speed and power settings for the selected job.

File Information Page	
Relevant Buttons	Function
F1 (Back)	Back to previous page
F4 (Edit)	Go to the File Management Edit Page for the selected job
Start / Stop	Back to Main Work Page
Auto Focus	Initiate the auto focus function
▲ / ▼ Manual Focus Buttons	Manually adjust the height of the work table (Z-axis)

File Management Edit Page

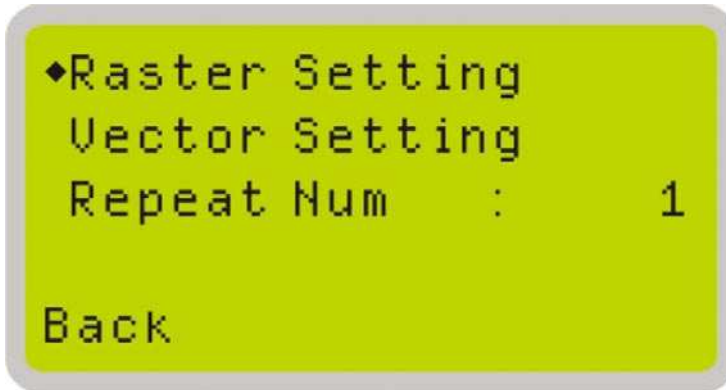

i Navigating to this page:

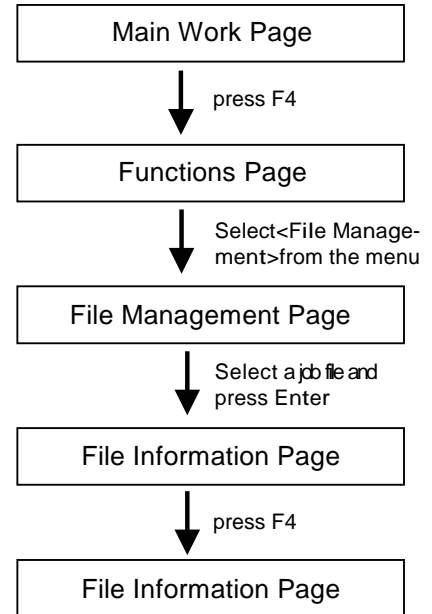

The File Management Edit Page allows you the choice to modify your raster or vector settings for the selected job, as well as setting the number of times to repeat the process of the selected job (Repeat Num).

File Management Edit Page	
Relevant Buttons	Function
F1 (Back)	Back to previous page
△ / ▽ Directional	Scroll through your loaded jobs
◀ / ▶ Directional	Cycle through the available selections
Enter	Perform the selection
Start / Stop	Back to Main Work Page
Auto Focus	Initiate the auto focus function
▲ / ▼ Manual Focus Buttons	Manually adjust the height of the work table (Z-axis)

File Edit Raster Page

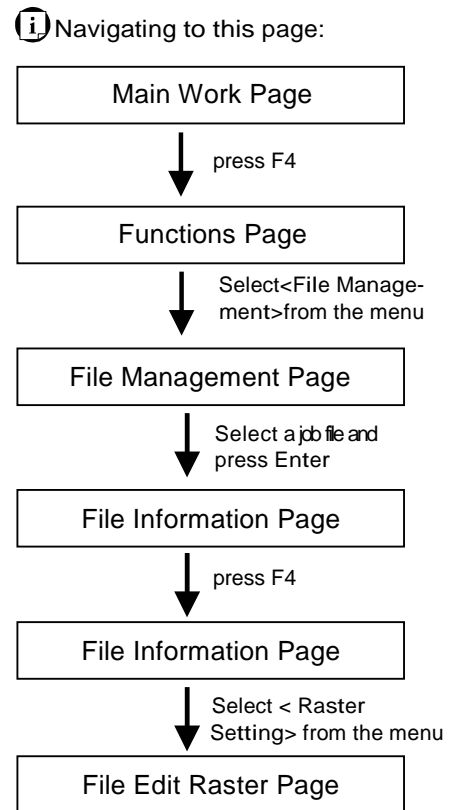
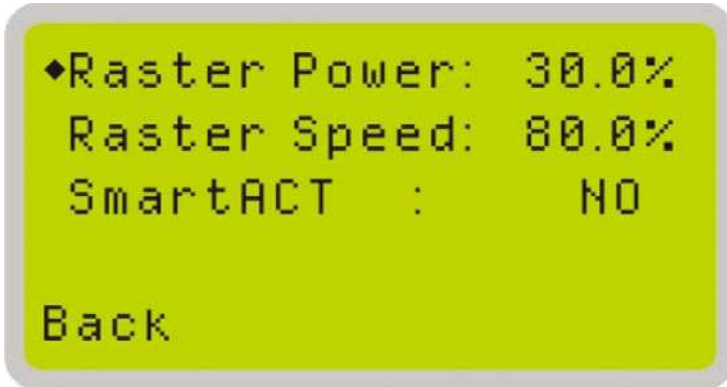

The File Edit Raster Page allows you to edit the raster power and speed settings, as well as enable or disable SmartACT for the selected job. These settings correspond to the same settings found on the LaserPro Spirit GX print driver. This page allows you to easily adjust these values to make immediate adjustments while processing your loaded jobs, even when you have disconnected your computer from the LaserPro Spirit GX.

- Raster Power: 0.0% - 100%
- Raster Speed: 0.0% - 100%
- SmartACT: YES / NO

File Edit Raster Page	
Relevant Buttons	Function
F1 (Back)	Back to previous page
△ / ▽ Directional	Scroll through your loaded jobs
◀ / ▶ Directional	Adjust the value for that selection
Start / Stop	Back to Main Work Page
Auto Focus	Initiate the auto focus function
▲ / ▼ Manual Focus Buttons	Manually adjust the height of the work table (Z-axis)

File Edit Vector Page

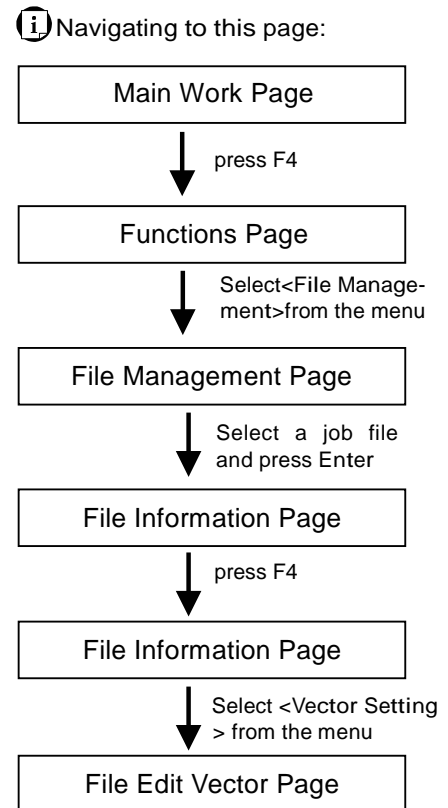
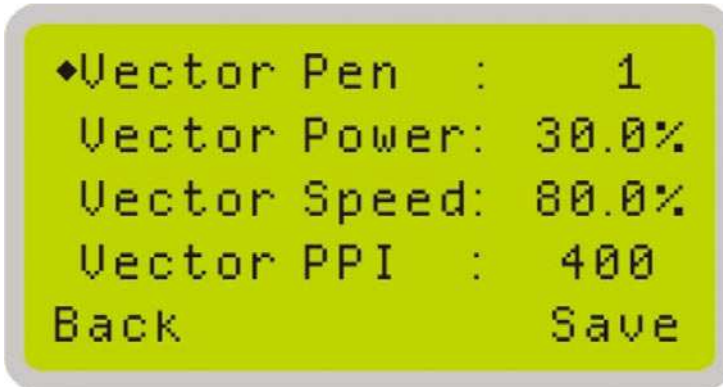

The File Edit Vector Page allows you to edit the vector pen, vector power, vector speed, and vector PPI, and power ramp settings for the selected job. These settings correspond to the same settings found on the LaserPro Spirit GX print driver. This page allows you to easily adjust these values to make immediate adjustments while processing your loaded jobs, even when you have disconnected your computer from the LaserPro Spirit GX.

- Vector Pen: 1 - 16
- Vector Power: 0.0% - 100%
- Vector Speed: 0.0% - 100%
- Vector PPI: 30 - 1524
- Power Ramp: YES / NO

File Edit Vector Page	
Relevant Buttons	Function
F1 (Back)	Back to previous page
F4 (Save)	Save your current settings
△ / ▽ Directional	Scroll through your loaded jobs
◀ / ▶ Directional	Adjust the value for that selection
Start / Stop	Back to Main Work Page
Auto Focus	Initiate the auto focus function
▲ / ▼ Manual Focus Buttons	Manually adjust the height of the work table (Z-axis)

Machine Setting Page

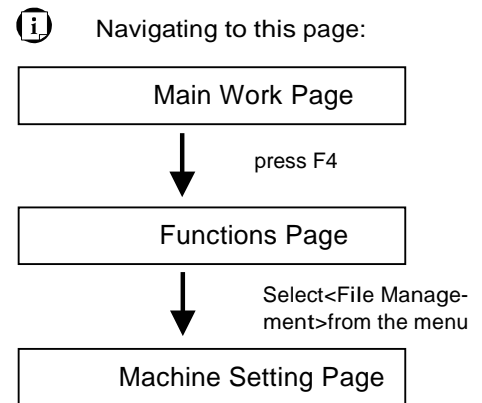
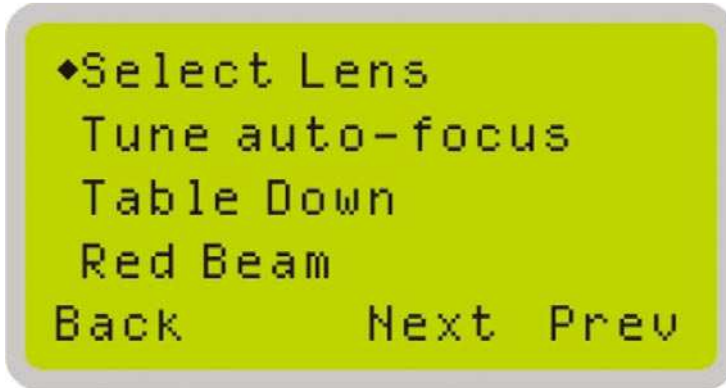

The Machine Setting Page allows you to access and modify various machine settings, including: Set Lens, Tune Auto Focus, Set Table Down, Set Red Beam, Carriage Lock, Set Command Mode, Save Position, Flash Memory, Set File Save Mode, Set Vector Mode, Tune Image Power, Set Laser Wattage, Set Fine Mode, Other, and Reset.

Machine Setting Page	
Relevant Buttons	Function
F1 (Back)	Back to previous page
△ / ▽ Directional	Scroll through your loaded jobs
Enter	Perform the selection
Start / Stop	Back to Main Work Page
Auto Focus	Initiate the auto focus function
▲ / ▼ Manual Focus Buttons	Manually adjust the height of the work table (Z-axis)

Set Lens Page

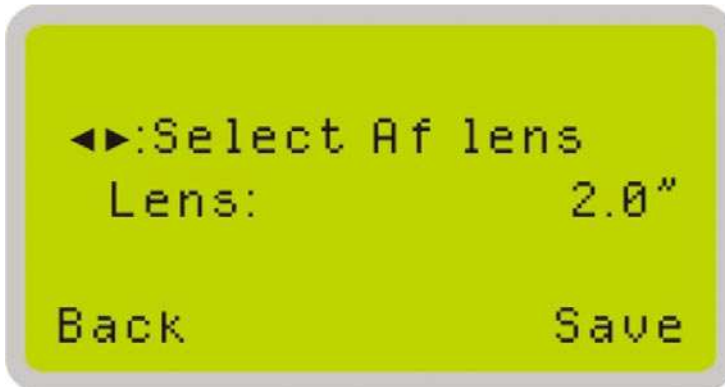

i Navigating to this page:

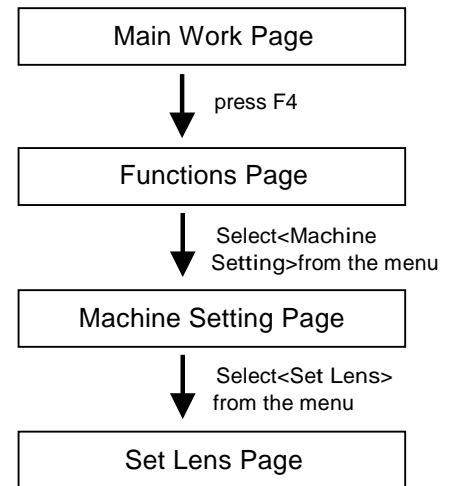

The Set Lens Page allows you to modify the lens settings after you have changed to a different focal lens. Remember to save your settings after you have made the proper changes. Now by pressing the Auto Focus button, the LaserPro Spirit GX will conduct auto focus accordingly using the new lens. The LaserPro Spirit GX's default setting is <2.0">

- Lens: 1.5" / 2.0" / 2.5" / 4.0"

Set Lens Page	
Relevant Buttons	Function
F1 (Back)	Back to previous page
F4 (Save)	Save your current settings
< / > Directional	Cycle through selections
Start / Stop	Back to Main Work Page
Auto Focus	Initiate the auto focus function
▲ / ▼ Manual Focus Buttons	Manually adjust the height of the work table (Z-axis)

Tune Auto Focus Page

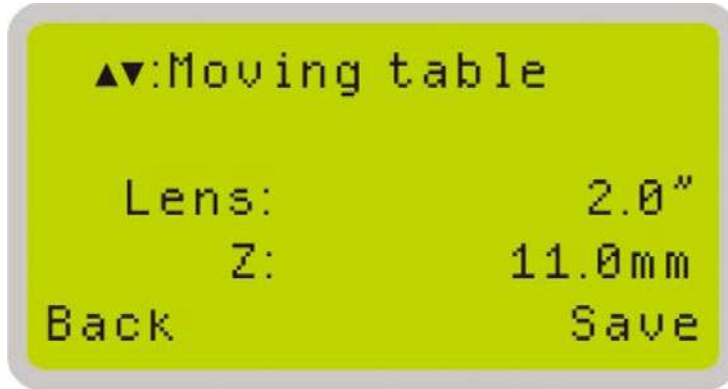

i Navigating to this page:

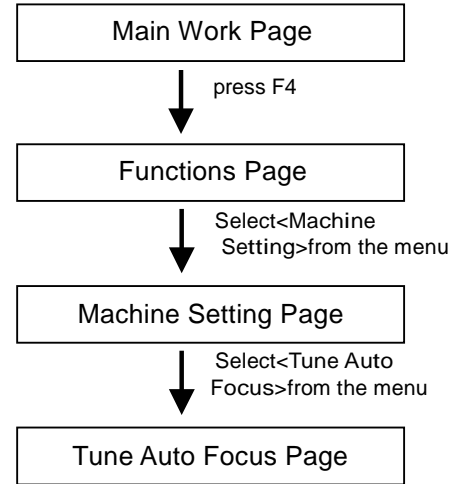

The Tune Auto Focus Page allows you to manually set the default auto focus distance / vertical height of the worktable (Z-axis) when the Auto Focus button is pushed.

Tune Auto Focus Page	
Relevant Buttons	Function
F1 (Back)	Back to previous page
F4 (Save)	Save your current settings
△/ ▽Directional	Manually adjust the height of the work table (Z-axis)
Start / Stop	Back to Main Work Page
Auto Focus	Initiate the auto focus function
▲ / ▼ Manual Focus Buttons	Manually adjust the height of the work table (Z-axis)

Set Table Down Page

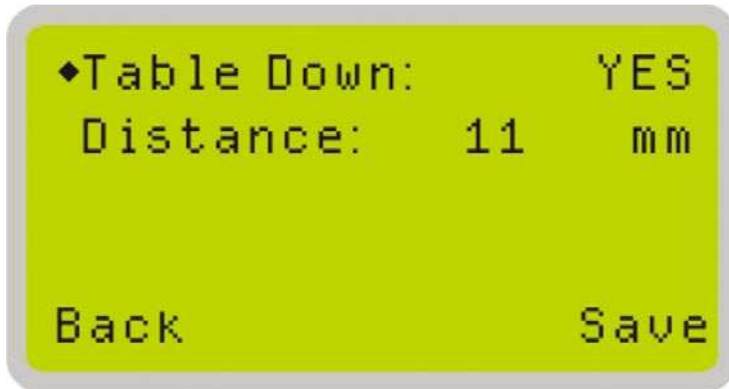

i Navigating to this page:

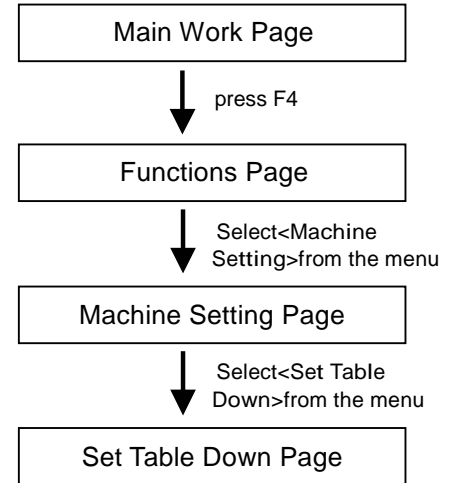

The Set Table Down Page allows you to select whether or not the LaserPro Spirit GX displays a warning prompt at startup. If the Table Down selection is set to <YES>, the LaserPro Spirit GX will display a warning prompt: at startup, stating: “Table will move down and remove objects on table”. Pressing the Enter key at this point will confirm the prompt to move the work table to its lowest position. If the Table Down is set to <NO>, then the LaserPro Spirit GX will not display this warning prompt at system startup.

- Table Down: YES / NO
- Distance: 0 - 165 mm

Set Table Down Page	
Relevant Buttons	Function
F1 (Back)	Back to previous page
F4 (Save)	Save your current settings
△ / ▽ Directional	Scroll through the menu selections
◀ / ▶ Directional	Adjust the value for that selection
Start / Stop	Back to Main Work Page
Auto Focus	Initiate the auto focus function
▲ / ▼ Manual Focus Buttons	Manually adjust the height of the work table (Z-axis)

Set Red Beam Page

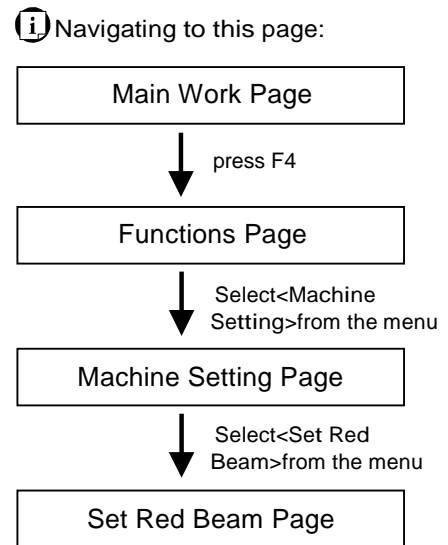
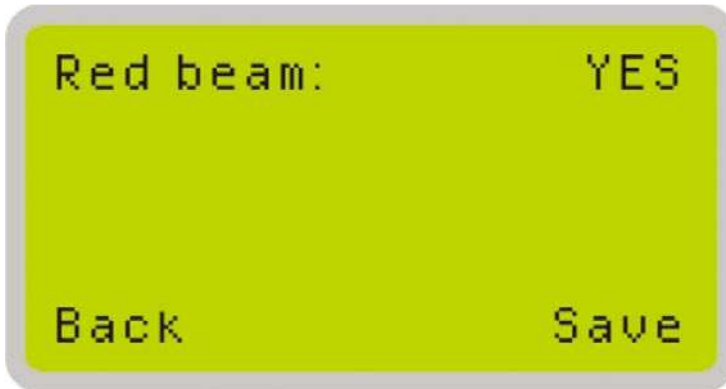

The Set Red Beam Page allows you to turn on or off the red dot laser pointer on the laser carriage. Enabling this function will indicate the exact area the engraving laser will fire upon.

- Red Beam YES / NO

Set Red Beam Page	
Relevant Buttons	Function
F1 (Back)	Back to previous page
F4 (Save)	Save your current settings
◀ / ▶ Directional	Cycle Red Beam between YES / NO
Start / Stop	Back to Main Work Page
Auto Focus	Initiate the auto focus function
▲ / ▼ Manual Focus Buttons	Manually adjust the height of the work table (Z-axis)

Carriage Lock Page

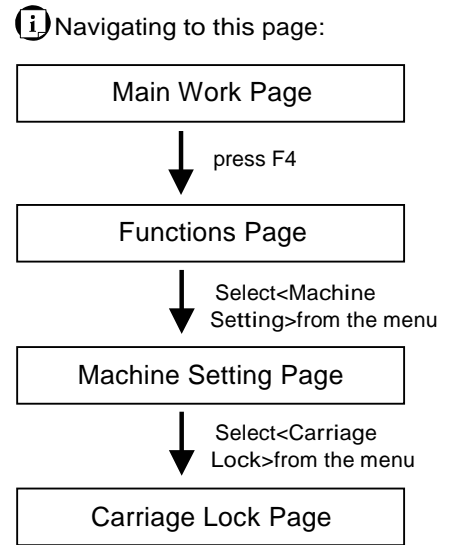
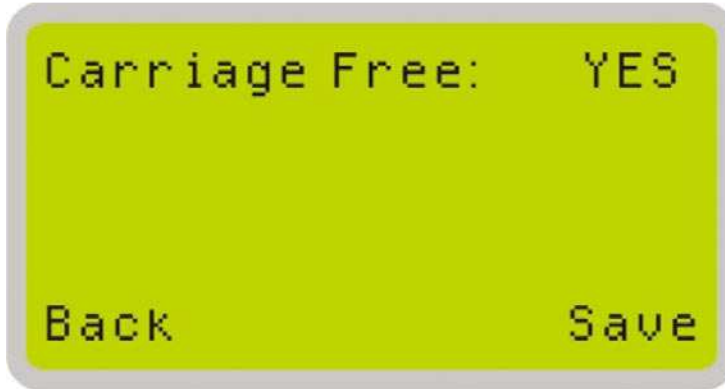

The Carriage Lock Page allows you to set whether the laser carriage is to be locked or free. If the Carriage Free setting is set to <YES>, then you will be able to manually move the laser carriage along the X and Y axis by hand with the top door open. Whereas setting the Carriage Free to <NO> will lock the laser carriage and movement or positioning can only be done by the control panel.

- Carriage Free YES / NO

Carriage Lock Page	
Relevant Buttons	Function
F1 (Back)	Back to previous page
F4 (Save)	Save your current settings
◁ / ▷ Directional	Cycle Carriage Free between YES / NO
Start / Stop	Back to Main Work Page
Auto Focus	Initiate the auto focus function
▲ / ▼ Manual Focus Buttons	Manually adjust the height of the work table (Z-axis)

Command Mode Page

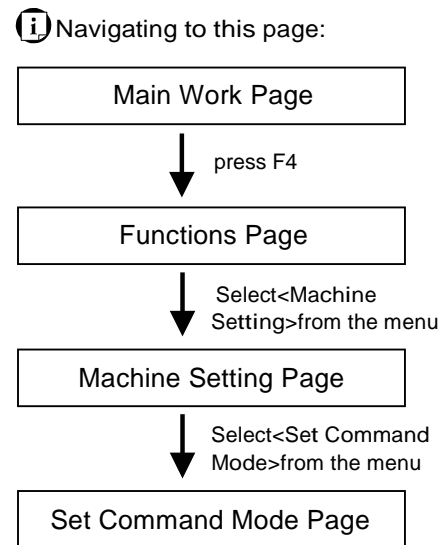
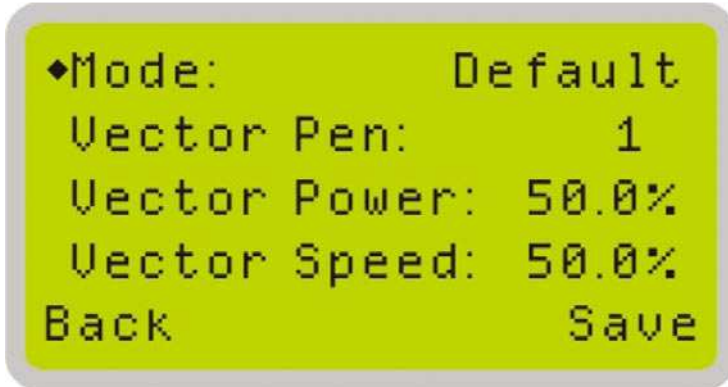

The Command Mode Page allows you to configure vector settings when outputting in Default or HPGL mode. Default mode is the standard Windows print driver and also recognized by the most popular graphic software programs such as CorelDraw, Photoshop, Illustrator, and more. Whereas, HPGL mode is a less common output format generated from some RIP applications (signage industry). Regardless of which format you will be working with, both output formats are supported.

- Mode: Default / HPGL
- Vector Pen: 1 - 16
- Vector Speed: 0.0% - 100%
- Vector PPI: 0.0% - 100%
- Power Ramp: YES / NO

Set Command Mode Page	
Relevant Buttons	Function
F1 (Back)	Back to previous page
F4 (Save)	Save your current settings
△/▽ Directional	Scroll through the menu selections
◀ / ▶ Directional	Adjust the value for that selection
Start / Stop	Back to Main Work Page
Auto Focus	Initiate the auto focus function
▲ / ▼ Manual Focus Buttons	Manually adjust the height of the work table (Z-axis)

Set File Save Mode Page

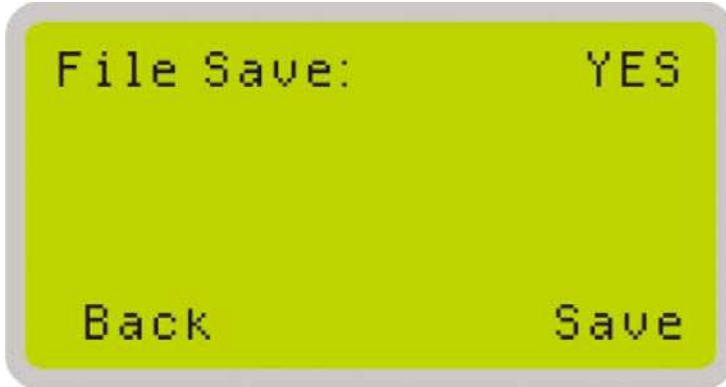

i Navigating to this page:

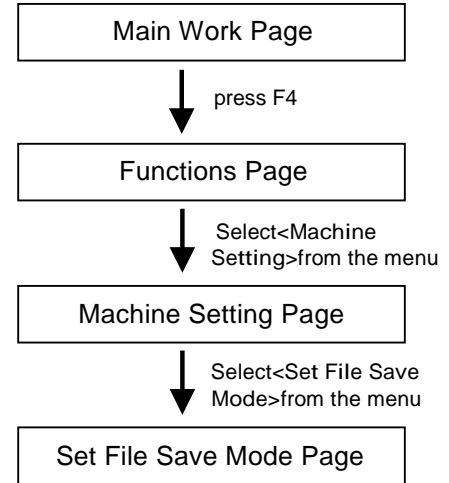

The Set File Save Mode Page allows you to set whether or not the LaserPro Spirit GX automatically deletes each job file after processing. Setting File Save to <NO> will automatically and immediately delete each job file from the LaserPro Spirit GX after the engraving or cutting process. Setting File Save to <YES> will retain all job files on the LaserPro Spirit GX.

- File Save: YES / NO

Set File Save Mode Page	
Relevant Buttons	Function
F1 (Back)	Back to previous page
F4 (Save)	Save your current settings
◁ / ▷ Directional	Cycle File Save between YES / NO
Start / Stop	Back to Main Work Page
Auto Focus	Initiate the auto focus function
▲ / ▼ Manual Focus Buttons	Manually adjust the height of the work table (Z-axis)

Set Auto-Standby Mode Page

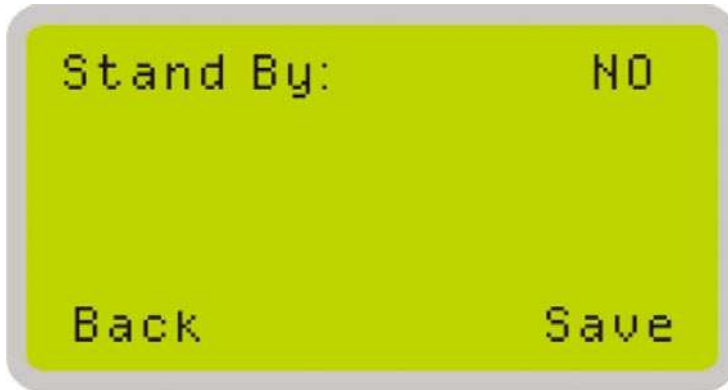

i Navigating to this page:

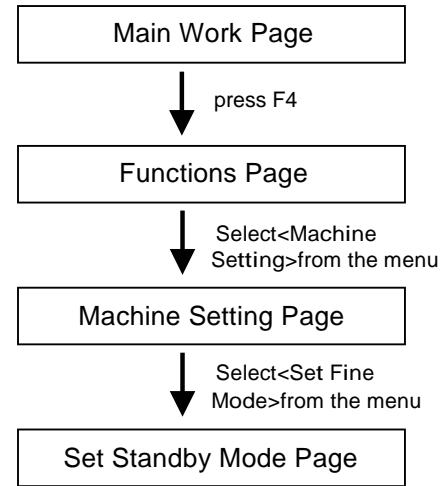

The Set Auto-Standby Mode Page allows you to turn ON or turn OFF the auto-standby timer. The machine will set itself to standby mode after being idle for 20 minutes when the Auto-Standby mode is turned ON.

- Set Auto-Standby mode: YES / NO

Set Auto-Standby Mode Page	
Relevant Buttons	Function
F1 (Back)	Back to previous page
F4 (Save)	Save your current settings
◁ / ▷ Directional	Cycle Auto Standby between YES / NO
Start / Stop	Back to Main Work Page
Auto Focus	Initiate the auto focus function
▲ / ▼ Manual Focus Buttons	Manually adjust the height of the work table (Z-axis)

Others Page



i Navigating to this page:

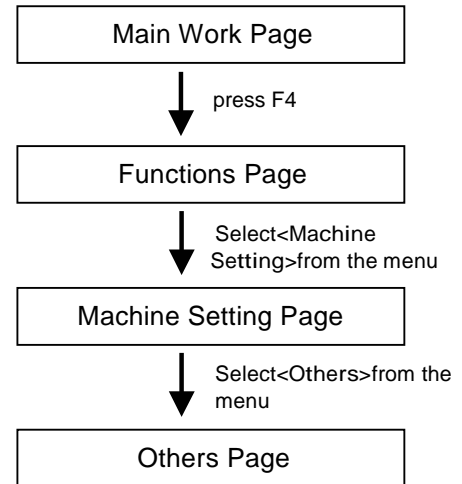

The Others Page allows you to change various settings that correspond to the control panel. The Language setting will allow users to change available languages displayed on the control panel. The Unit setting will allow you to change whether the units displayed by the control panel is in the metric or imperial system. The EOF (end of file) Alarm setting will enable or disable an audible notification when jobs are complete. The Air Delay setting allows you to specify the delay in seconds of the SmartAIR air-assist after the point of laser firing.

- Language: ENGLISH (others dependent on Firmware)
- Unit: METRIC / ENGLISH
- EOF Alarm: YES / NO
- Air Delay: 1-100 seconds



Tip

Depending on the material you are engraving with, your laser settings, and the desired results, please experiment with the air delay to achieve your desired results.

Others Page	
Relevant Buttons	Function
F1 (Back)	Back to previous page
F4 (Save)	Save your current settings
△/▽ Directional	Scroll through the menu selections
◀/▶ Directional	Adjust the value for that selection
Start / Stop	Back to Main Work Page
Auto Focus	Initiate the auto focus function
▲ / ▼ Manual Focus Buttons	Manually adjust the height of the work table (Z-axis)

Reset Page

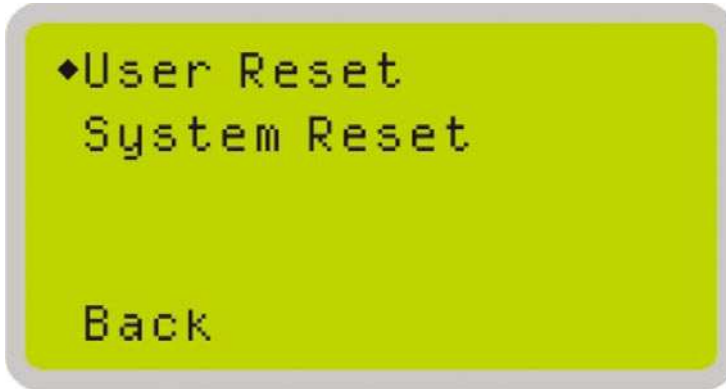

i Navigating to this page:

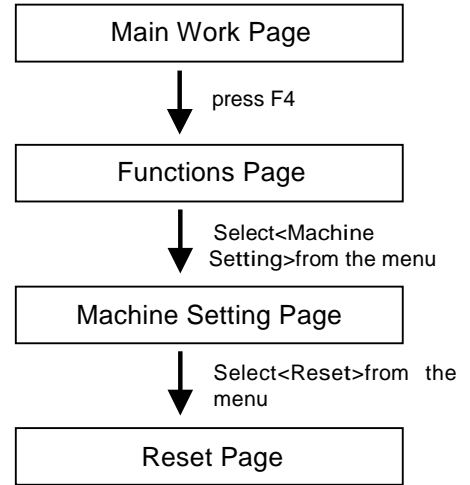

The Reset Page allows you to reset all changes made to the LaserPro Spirit GX's Machine Settings Page to their default settings. This does not affect the settings saved to an image file on the computer. The User Reset setting will set all settings back to default. After any firmware updates, you must use the System Reset setting (your previous settings are saved).

- User Reset (a confirmation will pop up, press Enter to confirm and continue)
- System Reset (a confirmation will pop up, press Enter to confirm and continue)

Reset Page	
Relevant Buttons	Function
F1 (Back)	Back to previous page
△/▽ Directional	Scroll through the menu selections
Enter	Perform the selection
Start / Stop	Back to Main Work Page
Auto Focus	Initiate the auto focus function
▲ / ▼ Manual Focus Buttons	Manually adjust the height of the work table (Z-axis)

Advanced Options Page

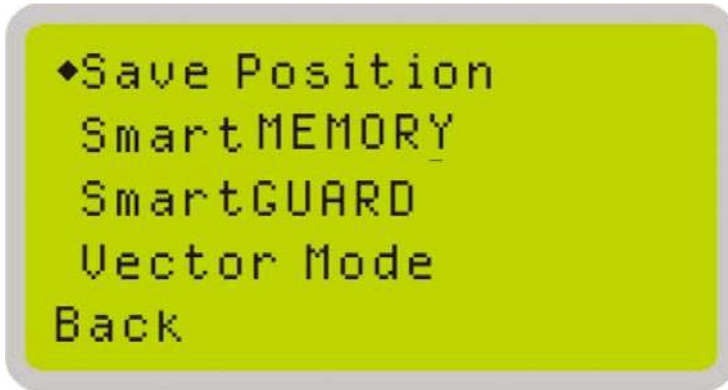

i Navigating to this page:

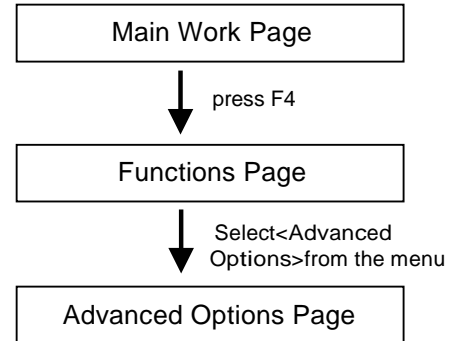

The Advanced Options Page allows you to use various advanced options such as: Save Position, SmartMEMORY, SmartGUARD, Vector Settings and Standby Mode.

Advanced Options Page	
Relevant Buttons	Function
F1 (Back)	Back to previous page
△/▽ Directional	Scroll through the menu selections
Enter	Perform the selection
Start / Stop	Back to Main Work Page
Auto Focus	Initiate the auto focus function
▲ / ▼ Manual Focus Buttons	Manually adjust the height of the work table (Z-axis)

Save Position Function

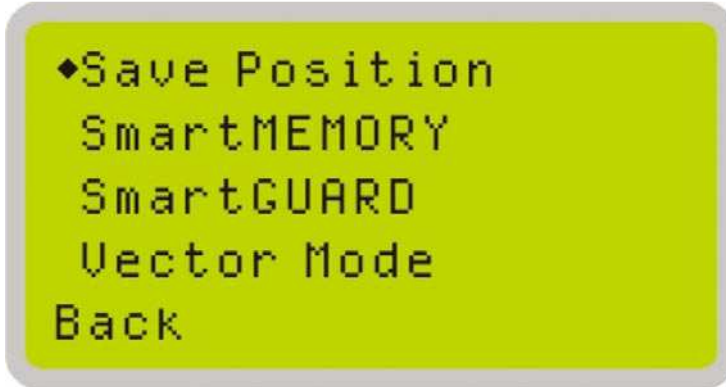

i Navigating to this page:

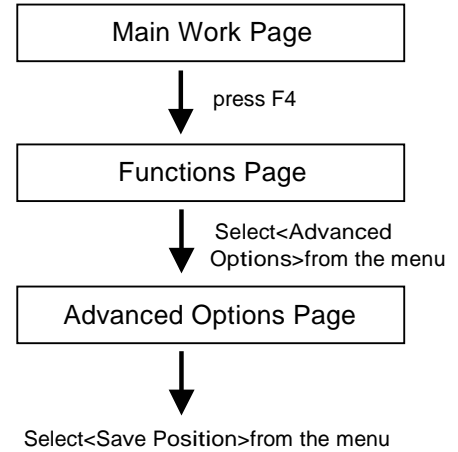

The Save Position Function allows you to save the current X-axis and Y-axis positions of the laser carriage and sets this position to be the origin for subsequent jobs.



Tip

This is an excellent function to use when you are processing identical items or engraving relatively smaller objects positioned away from the default start position (top left) of the work table.

Recall Position

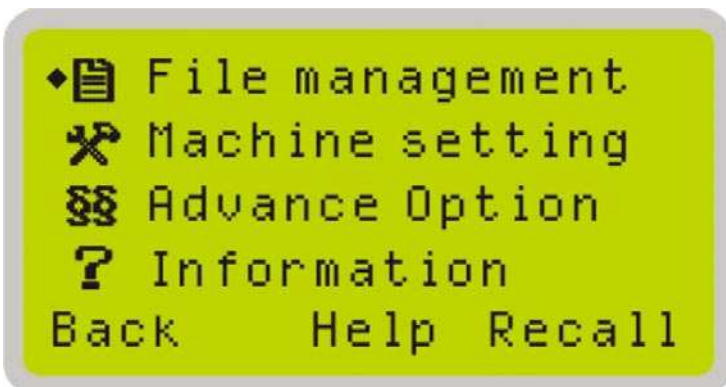

i Navigating to this page:

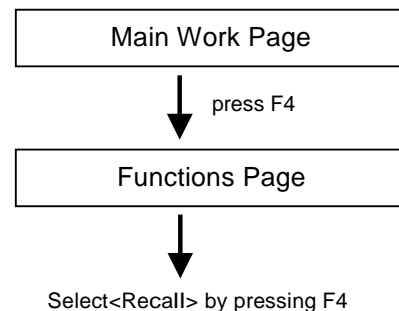

To recall the saved position, simply go to Functions page and press F4 again to recall the saved position. The laser carriage will be moved to the saved position.

SmartMEMORY Page



i Navigating to this page:

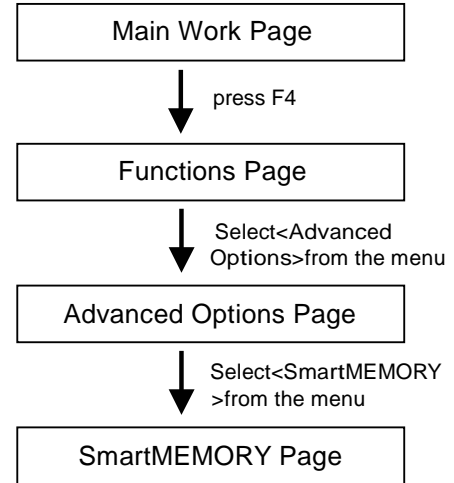

The SmartMEMORY Page allows you to read and write data with the optional SmartMEMORY module installed. Selecting <Save to SmartMEMORY> will copy all current jobs on the LaserPro Spirit GX to the SmartMEMORY module. Selecting <Load SmartMEMORY> will copy all job files from the SmartMEMORY module to the LaserPro Spirit GX.

SmartMEMORY Page	
Relevant Buttons	Function
F1 (Back)	Back to previous page
△/▽ Directional	Scroll through the menu selections
Enter	Perform the selection
Start / Stop	Back to Main Work Page
Auto Focus	Initiate the auto focus function
▲ / ▼ Manual Focus Buttons	Manually adjust the height of the work table (Z-axis)

SmartGUARD Page

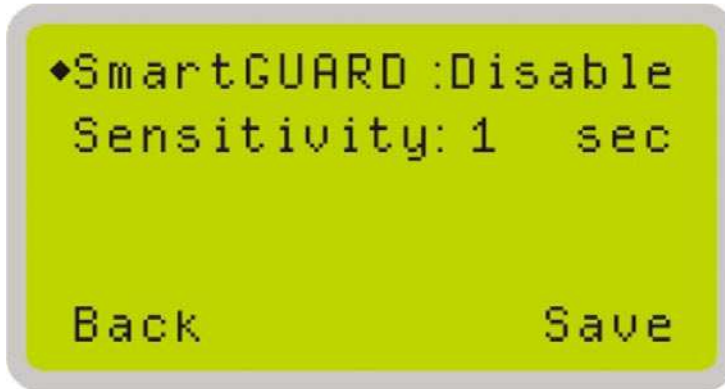

i Navigating to this page:

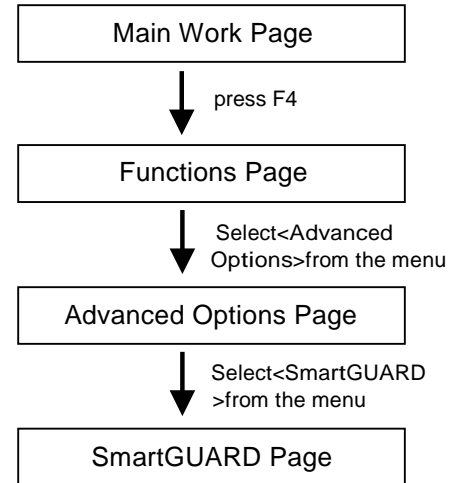

After hardware installation, please enter the function menu on the control panel to enable the SmartGUARD fire alarm.

SmartGUARD Enable / Disable:

Press directional key (left or right) to enable the SmartGUARD device or disable it.

Sensitivity :

Press directional key (left or right) to set the sensitivity of SmartGUARD. There are five sensitivity settings (1, 3, 5, 7, 9 seconds) that can be selected. Sensitivity is defined by the delay time from when a fire is detected until the fire alarm alerts user, and automatically shuts down the system. For example, if the sensor delay switch is set to the second position, the SmartGUARD will start an alarm and automatically shutdown the laser system after detecting a fire for 3 seconds.

SmartGUARD Setting Page	
Relevant Buttons	Function
F1 (Back)	Back to previous page
F4 (Save)	Save your current settings
△/▽ Directional	Scroll through the menu selections
◀/▶ (Directional)	Adjust the value for that selection

Vector Mode Page

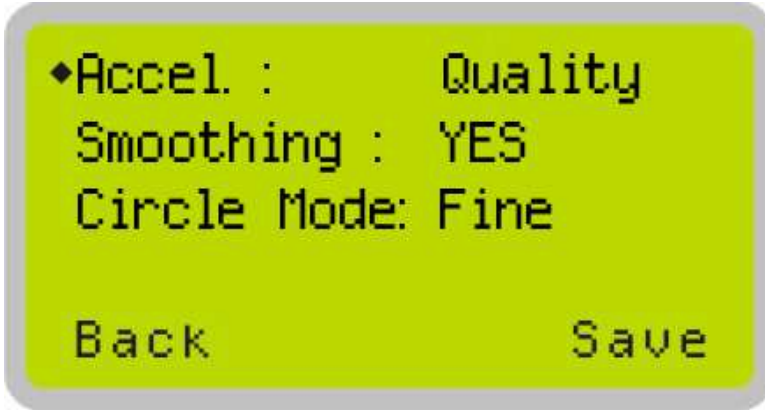

i Navigating to this page:

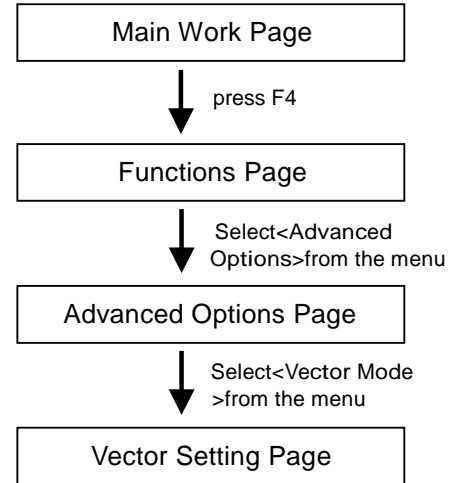

There are three options under the Vector Mode Page:

- (i) Acceleration Mode allows you to adjust and balance vector quality and speed settings based on your specific job. The Speedy Vector Option offers the highest output speed with average quality, whereas Quality Vector Option offers the highest quality at a slower output speed. Keep in mind that speed and quality are usually at a tradeoff. The Spirit GX system's default setting is set to <Fine Vector>.
 - Options: Quality Vector, Fine Vector, Coarse Vector, Speedy Vector
[Slower speed / higher quality ----- Faster speed / lower quality]
- (ii) When Smoothing mode is set to <YES>, an enhancing algorithm will be used to produce a finer and smoother circular output.
 - Smoothing: YES / NO
- (iii) When Enhanced Cutting mode is set to <YES>, time taken to cut small circles (diameter < 1cm) will be increased to generate better output in shape as well as cutting quality.
 - Circle Mode: Fine / Coarse / Quality

Vector Mode Page	
Relevant Buttons	Function
F1 (Back)	Back to previous page
F4 (Save)	Save your current settings
△/▽ Directional	Cycle through Vector Mode Settings
◁ / ▷ Directional	Cycle between options and YES / NO
Start / Stop	Back to Main Work Page
Auto Focus	Initiate the auto focus function
▲ / ▼ Manual Focus Buttons	Manually adjust the height of the work table (Z-axis)

Standby Page

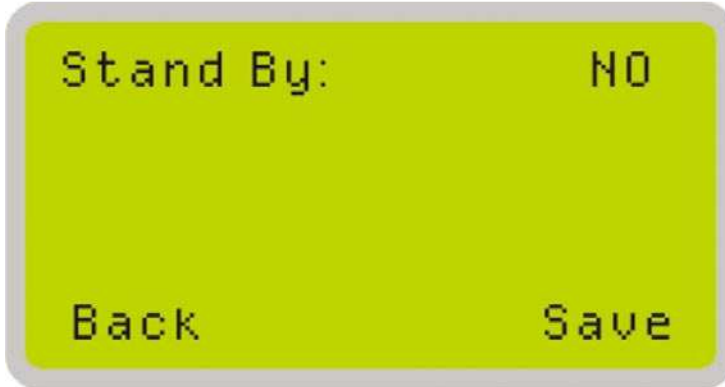

i Navigating to this page:

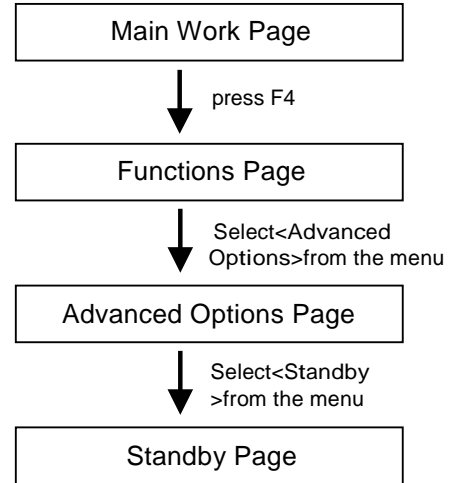

The Set Standby Page allows you to turn on or off the standby mode. Enabling this function will cause the machine to go into standby mode immediately.

- Standby YES / NO

Set Standby Page	
Relevant Buttons	Function
F1 (Back)	Back to previous page
F4 (Save)	Save your current settings
◀ / ((Directional)	Cycle Standby between YES / NO
Start / Stop	Back to Main Work Page
Auto Focus	Initiate the auto focus function
▲ / ▼ Manual Focus Buttons	Manually adjust the height of the work table (Z-axis)

Machine Information Page

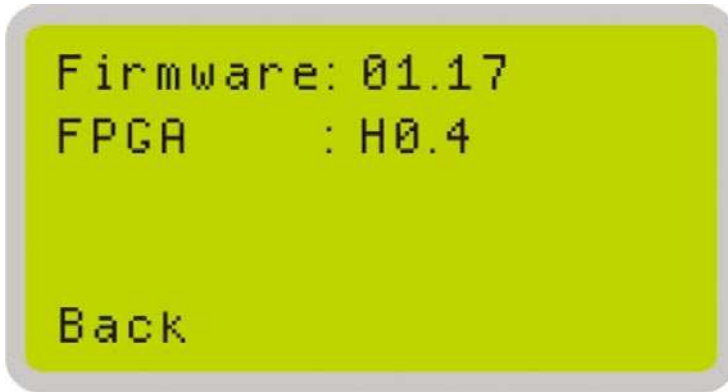

i Navigating to this page:

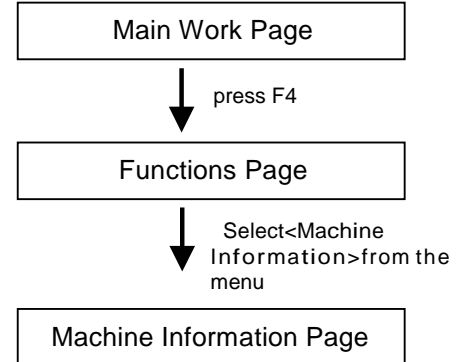

The Machine Information Page allows you to view information regarding the system such as the GCC logo, machine name, firmware version, and other information.

Machine Information Page	
Relevant Buttons	Function
F1 (Back)	Back to previous page
△/▽ Directional	Scroll through pages
Enter	Perform the selection
Start / Stop	Back to Main Work Page
Auto Focus	Initiate the auto focus function
▲ / ▼ Manual Focus Buttons	Manually adjust the height of the work table (Z-axis)

5.2 The LaserPro Spirit GX Print Driver

With the LaserPro Spirit GX print driver successfully installed, you will need to adjust the printer and page size default settings before you can begin editing and completing jobs. By doing so, you will be setting the work area in your graphics software to match the LaserPro Spirit GX's work table area.

NOTE

Please make sure the LaserPro Spirit GX is set to the default printer before proceeding to the page and layout setup.

Ensure that the LaserPro Spirit GX has been selected as the DEFAULT PRINTER. You can do so by going into your Windows Control Panel → Printers and Faxes

If the LaserPro Spirit GX is not selected as DEFAULT PRINTER, you may set it up through the graphics software as well. The following example takes CorelDraw to demonstrate how to set up LaserPro Spirit GX as the Printer.

- 1) From the primary menu, click FILE → PRINT SETUP.
- 2) From the navigation bar Name, click SpiritGX → OK

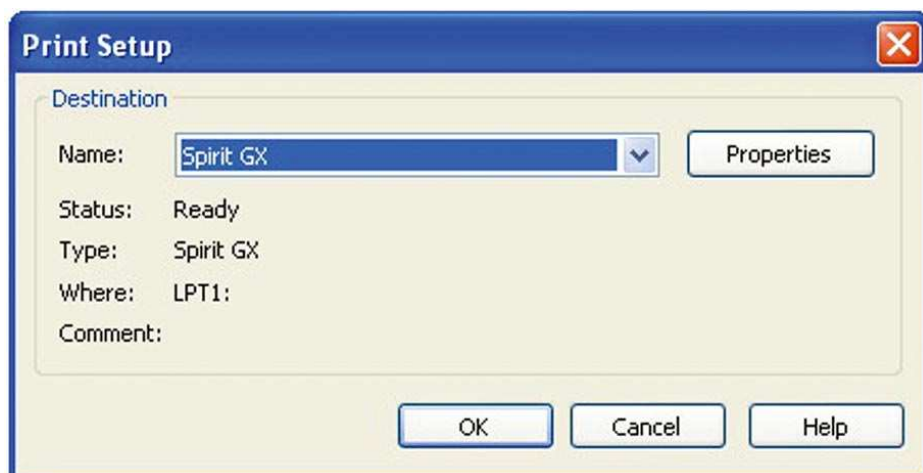

5.2.1 Page Setup and Orientation

The first thing you must do before working with the LaserPro Spirit GX Print Driver will be to make sure the page and layout settings are properly configured within your graphics software. You will need to access and edit the Page Setup or Layout page of your graphics software to set your graphics software's page layout to match the LaserPro Spirit GX's work table's dimensions and orientation.

From your graphic software's Page Setup page:

- Set the page orientation in the graphics software to Landscape mode.
- Set page size horizontal length to 860 mm (34 inches) or 965 mm (38 inches) and vertical height to 610 mm (24 inches).

CorelDRAW Example (Page Setup and Orientation)

The following is an example of how to set the Page Setup and Orientation in the graphics software. CorelDRAW is the designated graphics software used for this example. For other graphics software, you will need to access the corresponding Page Setup page.

- 3) From the primary menu, click LAYOUT → PAGE SETUP.
- 4) From the navigation bar on the left, click DOCUMENT → PAGE → SIZE.
- 5) Ensure that NORMAL PAPER and LANDSCAPE are selected.
- 6) Ensure the Paper Width and Height dimensions match the LaserPro Spirit GX's work table dimensions of 860mm (34 inches) and 610mm (24 inches) or 965mm (38 inches) x 610mm (24 inches).
- 7) Click OK to end the paper size adjustment.



Tip

Instead of manually selecting the Landscape and setting the Paper Width and Height, you can simply click the Set From Printer function and CorelDraw will automatically set the proper orientation and dimensions based on LaserPro Spirit GX's work table. (You MUST have the Spirit GX set as the default printer prior to doing this.)

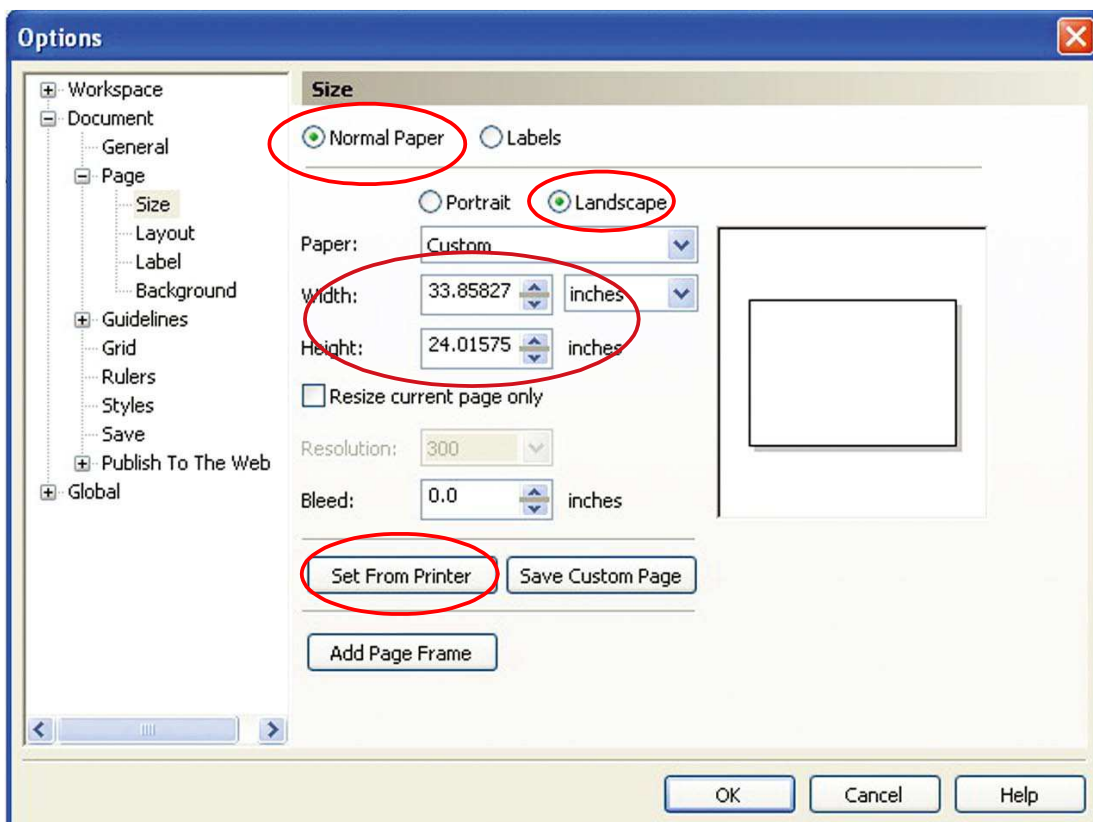

5.2.2 Color Management

The LaserPro driver uses pen color settings to control laser engraver's engraving and cutting parameters. In addition to having your Page Setup and Orientation properly set in your graphics software, you will also need to make sure Color Management is DISABLED prior to working with the LaserPro Spirit GX Print Driver.

From your graphic software's Color Management page:

- Disable Color Management or set Color Management to Off.

CorelDRAW Example (Color Management)

The following is an example of how to properly disable Color Management in the graphics software. CorelDRAW is the designated graphics software used for this example. For other graphics software, you will need to access the corresponding Color Management page.

- 1) From the primary menu, click TOOLS→COLOR MANAGEMENT and CorelDRAW's Color Management will appear.
- 2) Under the Style pull down menu, select COLOR MANAGEMENT OFF.
- 3) Click OK to complete the color management adjustments.

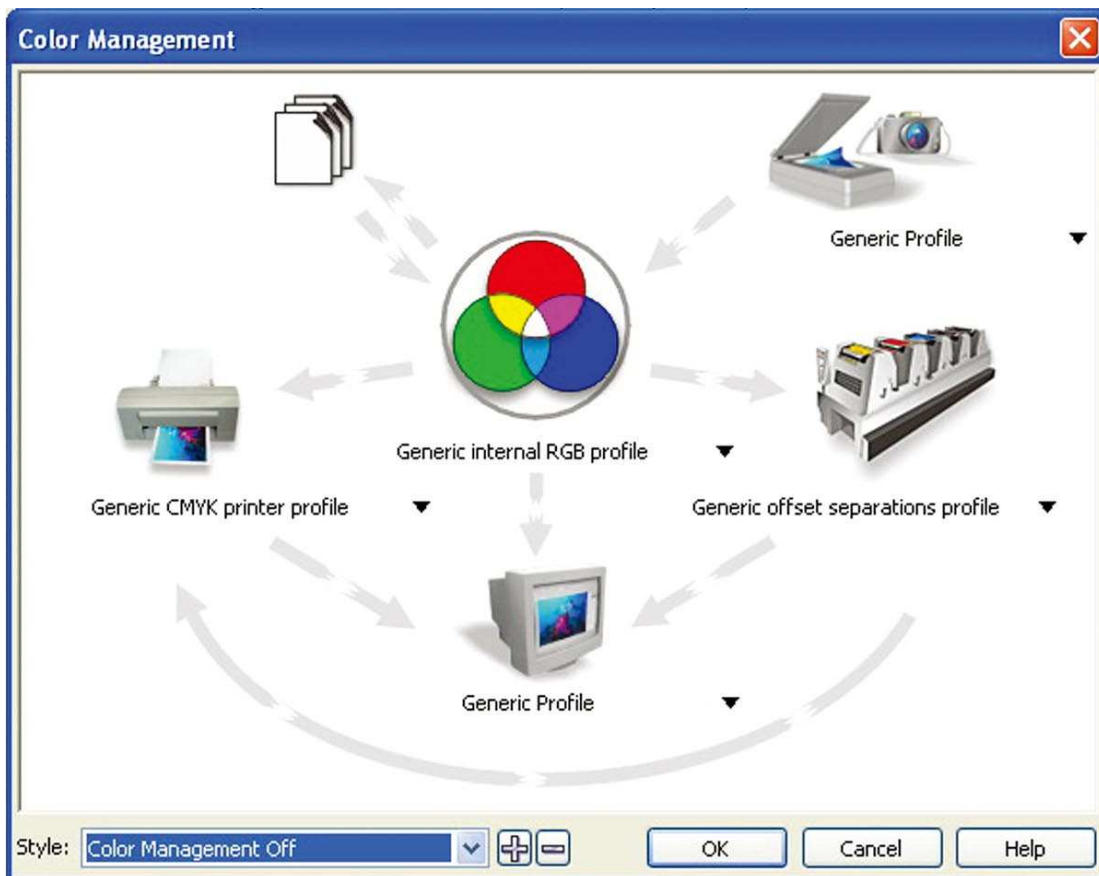

5.2.3 Using the LaserPro Spirit GX Print Driver

Now after you have properly set the Page and Layout and Color Management of your graphics software, you are ready to configure the details of your actual job through the LaserPro Spirit GX Print Driver. The LaserPro Spirit GX print driver allows you to adjust your engraving / cutting options. After you have setup your image, design, or text to be engraved in your software application, you can access the LaserPro Spirit GX print driver by going to FILE → PRINT → PROPERTIES.

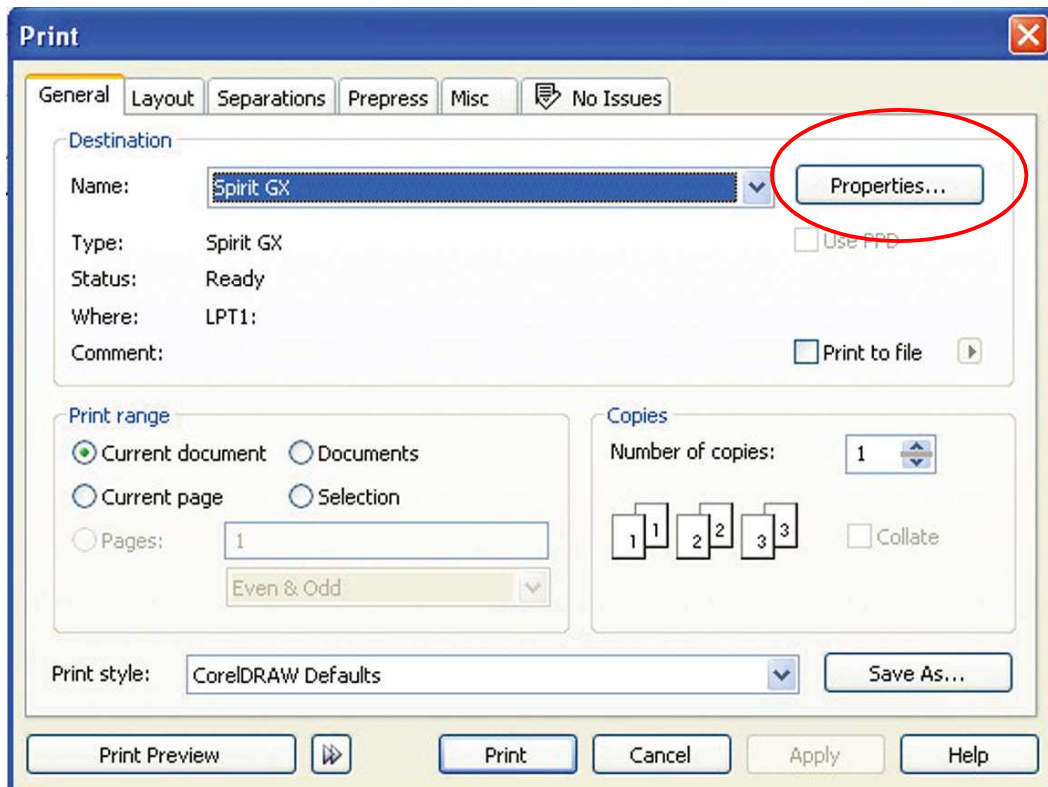

NOTE

For this screenshot example, CorelDraw was used as the software application.

The LaserPro Spirit GX Print Driver consists of seven primary sections (pages) in which you will be able to choose various engraving / cutting options and settings:

- Options Page
- Pen Page
- Advanced Page
- Paper Page
- Language Page
- Raster Page (appears only in Black & White Mode)
- Stamp Page (appears only in Stamp Mode)



Tip -----
 The following sections describe the specific functions for each of the settings found in the LaserPro Spirit GX Print Driver. If you are new to laser engraving, it is recommended that you first familiarize yourself with the general principles of the laser process in Section 6, especially the Vector Cutting and Raster Engraving concepts.
 This will make it easier to understand the various descriptions and terminologies used in this section.

5.2.3.1 LaserPro Spirit GX Print Driver >> Options Page

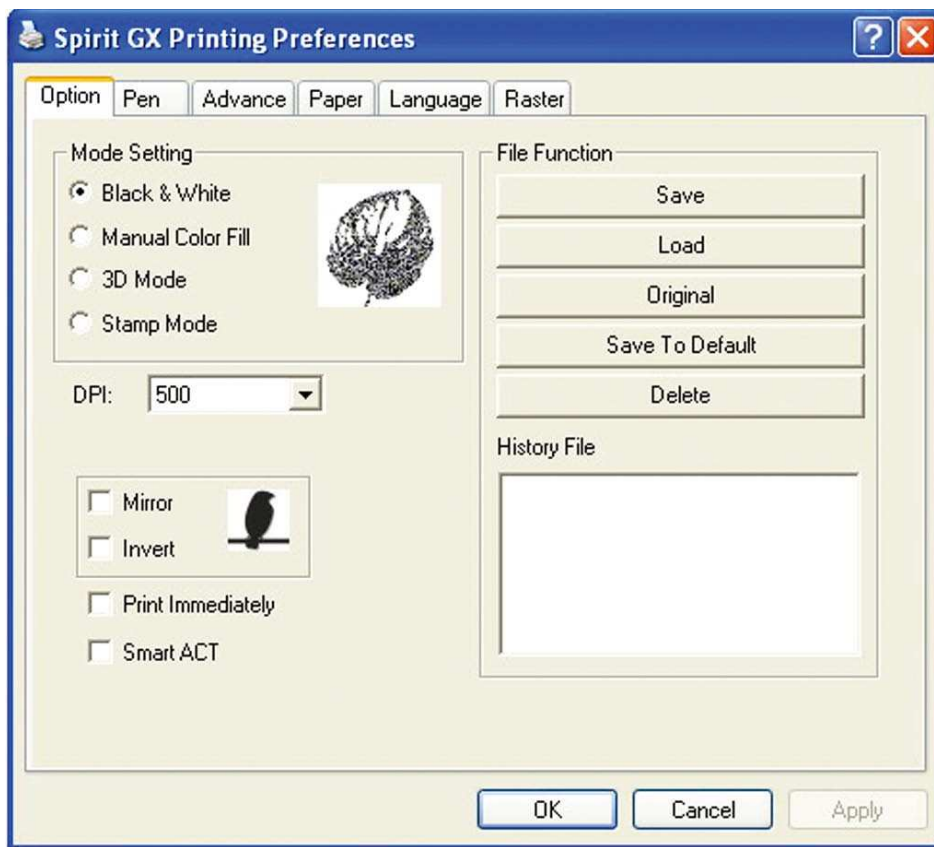

Mode Setting (OPTIONS PAGE) [DEFAULT SETTING: Black & White]

You can select from four primary mode settings, depending on your application or results you would like to achieve.

Black & White:

Select this mode when using clipart images or drawings with several colors, shades of gray, or many outlines. This mode outputs in a method similar to that of a black and white laser printer. The entire selected image will be engraved using a single set of power and speed settings (the black pen from the PEN menu. Please refer to the next section of the manual for details regarding the PEN functions).

The LaserPro Spirit GX print driver will interpret colored and shaded areas as different shades of gray by producing a halftone effect while engraving. Instead of engraving only solid lines, gray / halftone areas will be a collection of dots with varying density.

The resolution and depth of these halftone areas can be adjusted with the DPI setting found on the Options page. Please note that selecting the Black & White mode will add a new Raster page to the menu. The Black & White mode dithering settings can be changed from the Raster page.

(Please refer to the Raster section below for details). Experiment with different dithering settings to attain the desired results.



Tip

The Black & White mode interprets the processed image by the varying colors and shades. For the best results, we suggest you convert the image to a grayscale image with your graphics software prior to engraving in the Black & White mode.

NOTE

Selecting the Black & White mode will enable the Raster page on the LaserPro Spirit GX Print Driver, allowing you to adjust advanced stamp-related settings.

Manual Color Fill:

Select this mode when you would like to designate specific power and speed settings and link them to certain colors of your image. The LaserPro Spirit GX print driver allows a maximum of 16 pen parameters to be set.

3D Mode:

Select this mode to attain a sculptured 3D effect on your engraving. By using images that have a range of gray areas, the LaserPro Spirit GX print driver can manipulate the image to give it an added depth, by linking the laser power (depth of engraving) to specific colors. The settings can be adjusted through the DPI setting (Options page) and PPI, power and speed settings (Pen page).

Stamp Mode:

Select this mode when you would like to engrave stamps. The stamp mode is one of the more dynamic functions of the LaserPro Spirit GX. Due to the unique engraving nature when engraving a stamp, the stamp production requires different operational steps than most engraving or cutting operations.

NOTE

Selecting the Stamp mode will enable the Stamp page on the Spirit GX Print Driver, allowing you to adjust advanced stamp-related settings.

DPI (Options Page) [DEFAULT SETTING: 500]

DPI (dots-per-inch) represents the number of times the laser will fire over a one-inch path. This setting determines the image resolution and quality when performing raster engraving functions. Higher DPI settings result in cleaner and deeper engravings, but require more time to complete. Lower DPI settings result in coarser and shallower engravings, but require less time to complete. The LaserPro Spirit GX offers 8 DPI options: 125, 250, 300, 380, 500, 600, 760, and 1000, experiment with different settings to get your desired effect.

Below is a chart for your convenience detailing the Set DPI (your input setting) vs. Actual DPI (your output results).

Set DPI	125	250	300*	380	500	600*	760	1000
Actual DPI	127	254	381	381	508	762	762	1016

NOTE

Outputting a full-table (34" x 18") job using 300 or 600 DPI will result in a truncation error; this is due to the large differences in set DPI vs. actual DPI output for those two particular DPI settings. Therefore, when processing a 34" x 18" job using 300 DPI, we recommend you move to the next higher DPI setting of 380. Similarly, for a 34" x 18" job using 600 DPI, we recommend you use 760 DPI.

Mirror (Options Page) [DEFAULT SETTING: Unselected]

Checking this box will automatically engrave your image with a mirrored effect. This setting will flip the image along the Y-axis from left to right and vice-versa.



Tip

When engraving a stamp, via the stamp mode, the stamp image needs to be engraved in reverse (mirrored) for the final stamp to be correctly laid out.



Invert (Options Page) [DEFAULT SETTING: Unselected]

Checking this box automatically inverts / reverses the color of your image (the white areas become black and vice versa). The Invert option is not available if disabled while Manual Color File mode is selected.

Tip 

Invert mode is useful when creating a stamp in Stamp Mode, as inverting your normal image will set the negative space to be engraved out, with the remaining positive space (your stamp design) protruding out.



Print Immediately (Options Page) [DEFAULT SETTING: Unselected]

Checking this will instruct the LaserPro Spirit GX to immediately begin the laser engraving process, when you select Print from your graphic software program. If Print Immediately is not checked, then selecting Print will transfer the job file to the LaserPro Spirit GX system and will need to be initialized from the LaserPro Spirit GX control panel.

SmartACT (Options Page) [DEFAULT SETTING: Unselected]

SmartACT reduces the amount of time it takes to process a job, by eliminating unnecessary travel of the laser carriage at the expense of some quality. Usually the quality loss is minimal, but will depend on the image or design you are working with; please take some time to experiment with your particular design to determine whether the tradeoff is acceptable. When selected, the working area will be extended as well.

Tip 

There is a greater performance gain when enabling SmartACT for designs that are vertically longer than they are horizontally wide, as the SmartACT optimization modifies the movement of the X-axis of the laser carriage.

File Function (Options Page):

The file function section allows you to manage various laser parameters. This section is useful when performing duplicate jobs on a variety of objects, allowing you to save your frequently used laser parameters and load them in the future.

- History File: This section contains a list of the recent files you have recently created and worked with.
- SAVE: This function will save the current print driver parameter settings to a file and location on your computer of your selection. (Saved parameter setting files will be tagged with the .H2O extension)
- LOAD: This function allows you to load those previously saved print driver parameters.
- ORIGINAL: This function will load the print driver's original factory parameter settings.
- SAVE TO DEFAULT: This function allows you to save your current print driver parameters as the default startup settings.
- DELETE: This function will delete the file you select from the History File section. Please note the Delete function only removes the file from the history file section, it does not remove the H2O file from your hard drive, if you wish to completely remove the file from your hard disk, then you will have to manually delete the file from your operating system.)

NOTE

If you are using Windows 2000 or XP as your operating system, then make sure you log in with an administrator or administrator-rights account in order to properly save laser parameter settings.

.2.3.2 Spirit GX Print Driver >> Pen Page

The LaserPro Spirit GX incorporates the use of 16 different colors to represent 16 different laser power and speed settings when cutting and engraving. These colors are referred to as “Pens”. Think of each pen as a designated laser setting, rather than as a color. As an example, a black and white image will use only one power and speed laser setting (Black). An image that is made up of black, red and blue colors will be processed using the laser settings designated for each particular color. In order to utilize up to 16 different pens (laser parameter settings), make sure your graphics software can recognize and utilize the 16 pen colors designated by the Spirit GX print driver

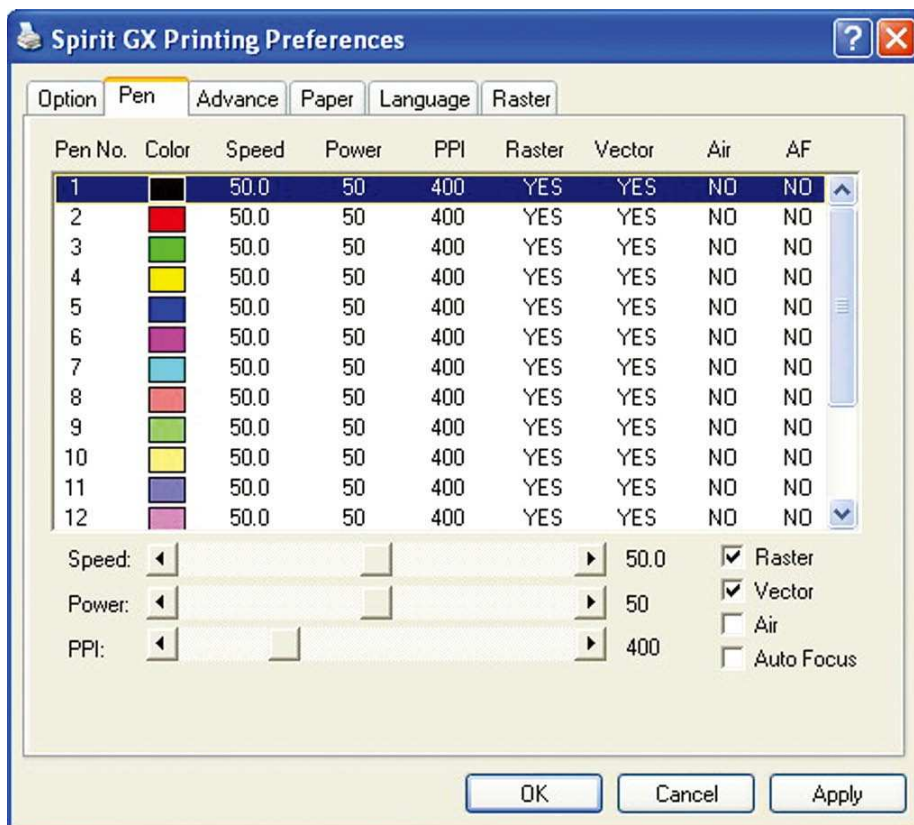

If you would like to specify your own colors to designate to a particular laser setting, then all you have to do is to double-click on that particular pen color from the pen menu and a color manager window will open where you can select “define custom colors” to define your own color (shown in the picture below). This is useful when your image is composed of colors that are not part of the pen menu’s default color selection, and instead of modifying your image, you simply assign the laser settings based on the existing colors depicted from your current image.

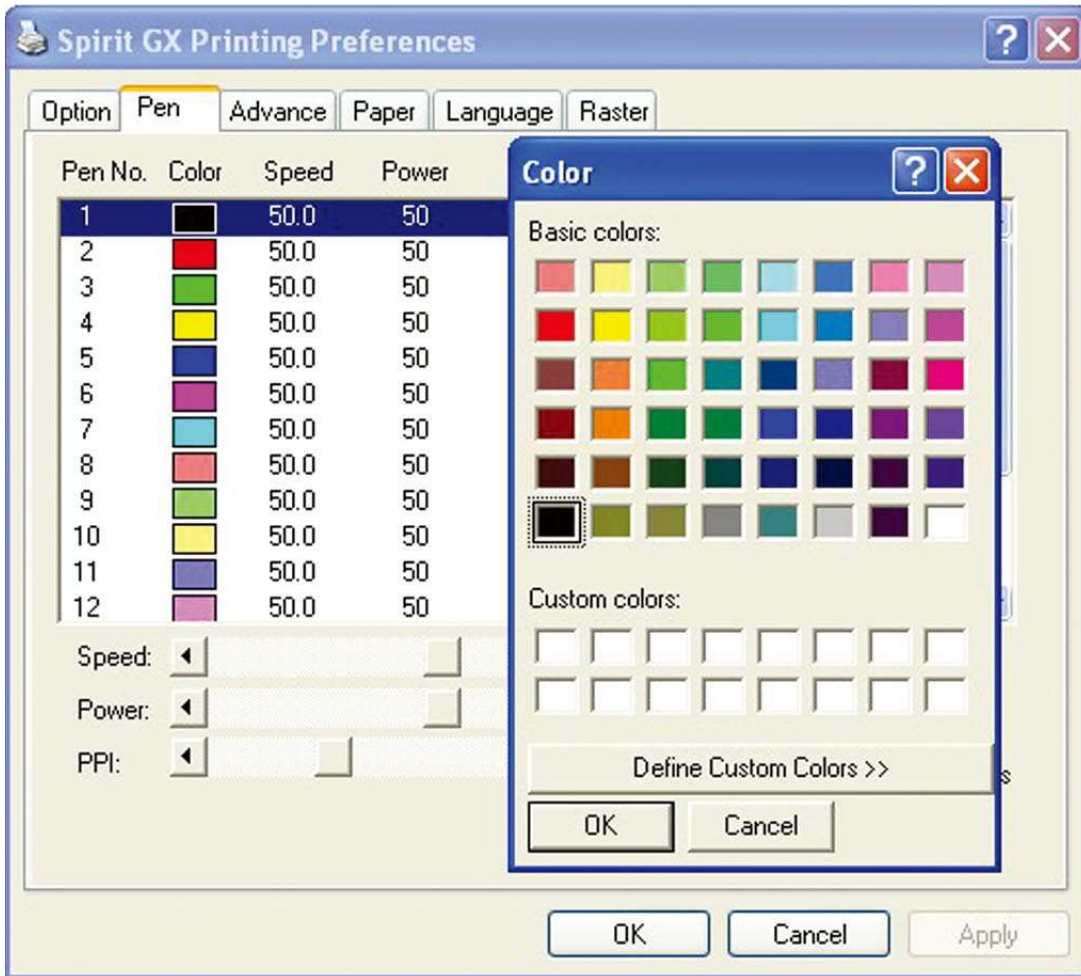

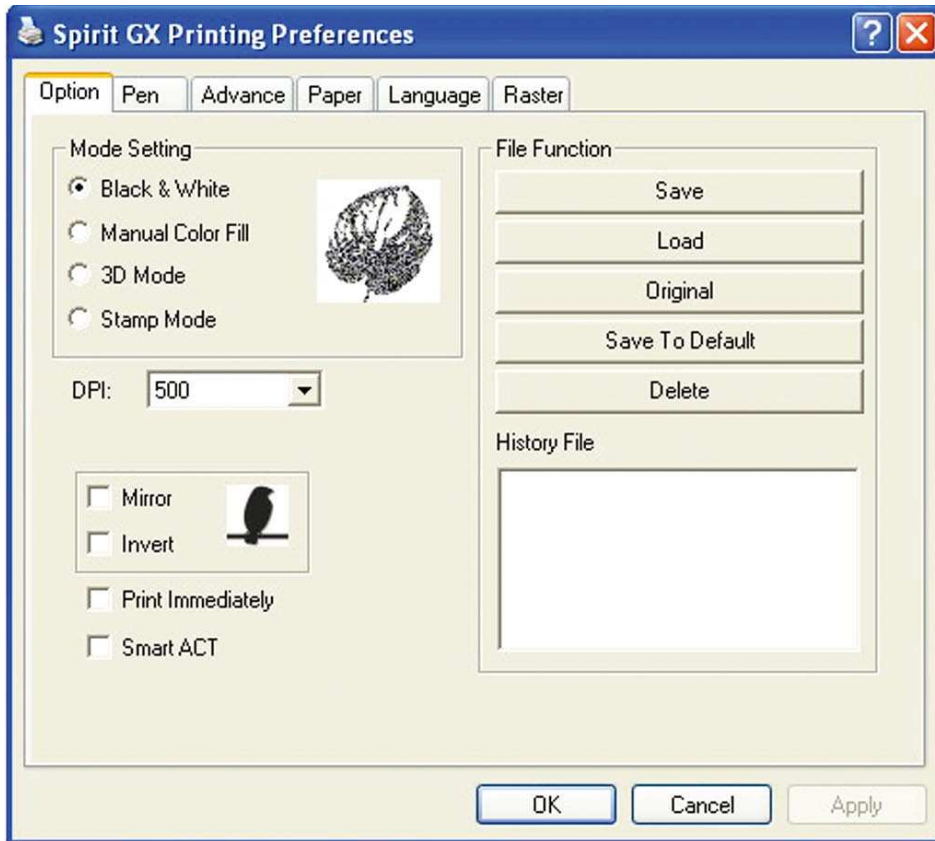

NOTE

The Spirit GX print driver cannot store more than 16 pen colors or different laser parameter settings per file.

Speed (Pen Page) [DEFAULT SETTING: 50]

The speed slider controls the laser's speed during operation (engraving speed) with settings ranging from 0.1 – 100%. The Spirit GX's maximum laser processing speed is 80 inches per second, therefore a setting of 100% speed is equivalent to 80 inches per second and a 10% speed setting would be equivalent to 8 inches per second. Keep in mind, this is the speed the laser moves at when cutting or engraving straight lines. The machine will automatically slow down when processing curves.



Tip

Cutting / engraving depth and quality are determined by a combination of power and speed. Slower speeds at higher power will produce deeper cuts and engravings, whereas higher speeds at lower power will produce more shallow cuts and engravings.

Power (Pen Page) [DEFAULT SETTING: 50]

The power slider controls the laser's power during operation (engraving power) with a range setting from 1 – 100%. The percentage setting represents the power for each laser pulse fired.

PPI (Pen Page) [DEFAULT SETTING: 400]

PPI (pulses-per-inch) represents the number of times the laser pulses (fires) per linear inch, exclusive for vector cutting. Higher PPI settings will generate deeper, overlapping laser pulses, resulting in cleaner cuts. Lower PPI settings (lower than 150) will result in the individual laser pulses being spread apart, resulting in a perforated effect (similar to the perforation in the paper between mailing stamps).

If you drag the PPI slider to the furthest right (maximum), the value will change to X. This completely disables the PPI control and continuously fires the laser non-stop, without pulsing.

Think of setting PPI to X as being equivalent to turning a water faucet on with the water continuously flowing out. This also disables the power ramp functionality, which automatically controls the PPI depending on the speed of the laser carriage (such as vector cutting around the corner of a square).



Tip

- For Vector Engraving jobs, we recommend a PPI setting > 150
- For Vector Cutting jobs, we recommend a PPI setting of > 400

Raster / Vector (Pen Page) [DEFAULT SETTING: Selected]

Checking the Raster checkbox will process only the raster functions for the areas of your design that correspond to that particular "pen" color.

Checking the Vector checkbox will process the vector functions for the areas of your design that correspond to that particular "pen" color.

As an example: a particular "pen" color may be assigned to areas in your design containing color fills (raster engraving) and very thin lines (vector cutting). By checking / unchecking the Raster and Vector will force the driver to process / ignore the color fills / thin lines.

	Vector Checked	Vector Unchecked
Raster Checked	Processes both Vector and Raster functions for that particular color	Processes only the Raster functions for that particular color (Vector functions ignored)
Raster Unchecked	Processes only the Vector functions for that particular color (Raster functions ignored)	Does not process Vector or Raster functions for that particular color

Air (Pen Page) [DEFAULT SETTING: Unselected]

This checkbox controls the SmartAIR air-assist function (if you have the optional air compressor installed). By selecting a pen color and checking this box will enable the SmartAIR air-assist function for that particular pen color. As an example, if you are performing a combination of both surface raster engraving job and deep vector cutting on a material such as acrylic, you may want to enable the SmartAIR air-assist for the vector cutting sections to get the cleanest cuts. To do this, you would simply need to select the pen color that you have assigned to the sections to be cut and select the Air checkbox for those particular pen colors.

Auto Focus (Pen Page) [DEFAULT SETTING: Unselected]

This checkbox sets the Auto Focus for that particular job. With the Auto Focus button checked, the Spirit GX will automatically initialize the auto focus procedure before starting the job. This will ensure the focal distance is properly set based on the particular material you are working with and the focal lens you have installed.

5.2.3.3 Spirit GX Print Driver >> Advanced Page

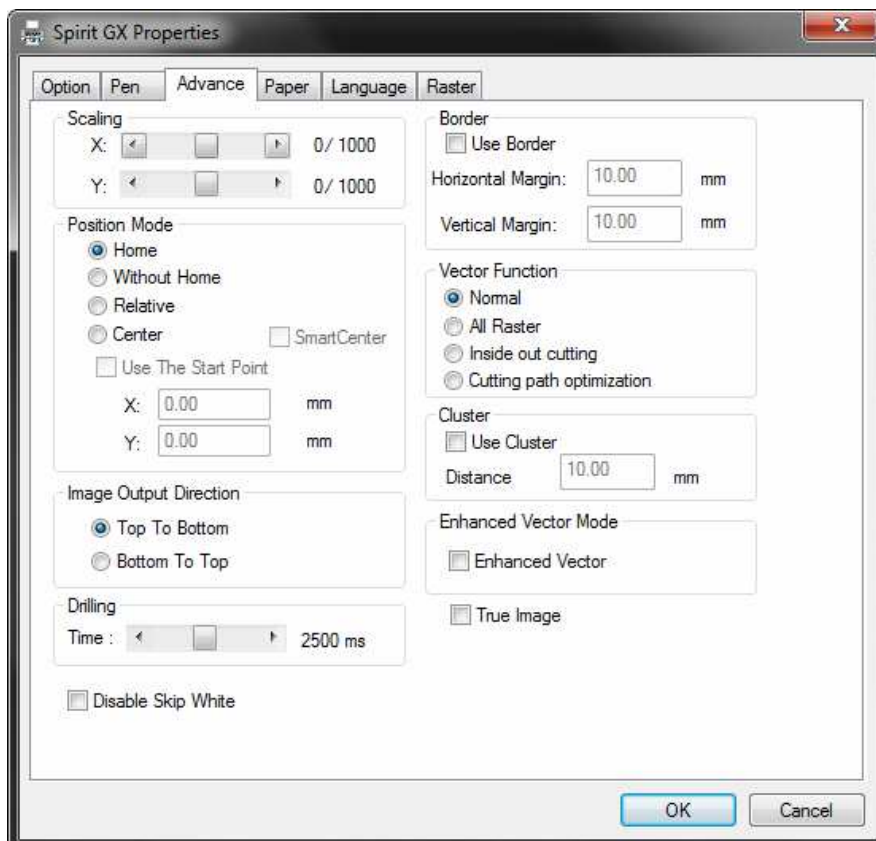

Scaling (Advanced Page) [DEFAULT SETTING: 0]

In some cases you may find a slight output inaccuracy in the actual output compared to what you have set in the computer. This margin of error or offset is extremely small (approximately 1/300). What this means is that there may be a 1-unit offset for every 300 unit increments. As an example, if you engrave a 300mm straight line, it may end up measuring only 299 mm or 301 mm in the final output. In this case, you will want to set the scaling setting to +1/1000 or -1/1000 respectively to compensate. A general rule of thumb is for every 300 unit increment, you will want to adjust the slider by +1 if the final output is 1 unit increment shorter or -1 if the final output is 1 unit increment longer than your graphic design setting.

Position Modes (Advanced Page) [DEFAULT SETTING: Home]

These selections allow you to control the positioning of the laser head after each job completion and before the next subsequent job.

- Home: Resets the positioning of the laser head to the 'home position' (upper-right) before and after each job.
- Without Home: The laser head will start the next job based on the position from its graphic application software setting, from the last position of the previous job. Upon completion of the current job, the laser head will remain at the last position of the previous job.
- Relative: This mode sets the current laser head position to correspond to the origin (top left) position of the graphic software. Therefore, the laser head will process the job from its current position relative to its setting in the graphics software.
- Center: Sets the current position of the laser head as the center point for your subsequent job. As an example, if the subsequent job is to vector cut a circle and you have the Position Mode set to Center, then the Spirit GX will vector cut a circle around the initial position of the laser head.
- SmartCENTER: The SmartCENTER mode is an enhanced version of the center mode and will determine the center point between two objects. User can pinpoint and save two distinct points and by moving the pen carriage using the red beam as a reference. When this mode is selected, the machine will prompt the user to move the lens carriage to store the location of the first position and then prompt the user to move the lens carriage again to store a second position. Once the two positions are stored, the pen carriage will automatically position itself to the center of the saved positions.



Tip

The SmartCENTER function is a quick and easy way to precisely locate the center point between two points. A great tool for users whose jobs often require engraving on specific locations such as on award signs and plaques.



Tip

It is highly recommended you enable the red dot laser pointer when setting / adjusting the Position Modes, as this will ease your job positioning with enhanced accuracy.

Image Output Direction (Advanced Page) [DEFAULT SETTING: Top to Bottom]

These selections allow you to control the direction in which the system processes an engraved image.

- **Top To Bottom:** Selecting this will force the system to process the current task by moving the laser carriage from the top to the bottom of the image (rear end to front end of the work table).
- **Bottom To Top:** Selecting this will force the system to process the current task by moving the laser carriage from the bottom to the top of the image (front end to rear end of the work table)

Normally, the LaserPro Spirit GX engraves from left to right, top to bottom. Selecting Bottom Up will force the machine to start from the bottom and work its way to the rear of the working table.



Tip

In situations where the material you will be working with may produce a lot of dust byproducts and you are utilizing the optional air extraction system, it is recommended that you select the Bottom To Top image output direction option. This will minimize the amount of dust byproducts lodged in the engraved sections as the air extraction system is vented from the rear of the machine, the same direction as the image is processed.

Border (Advanced Page) [DEFAULT SETTING: Unselected]

In cases where you are working with a negative image (negative outline areas of your image are engraved, rather than the positive areas), you may wish to include a border around your image. To properly add a border, you will first need to Invert your design from the Options Page, then check Use Border and specify a value for the thickness of the border you would like to add to your design.

This mode is useful for engraving rubber stamps, as it allows you to create the outline around your stamp image.

NOTE

If you wish to use the Border and Cluster function simultaneously, then the Border Thickness value must be less than the Distance value specified in the Cluster setting.

Vector Function (Advanced Page) [DEFAULT SETTING: Normal]

- Normal: This selection will not apply any special advanced vector function to your job. This is the default Vector Function setting.
- All Raster Output: This selection will instruct the print driver to process your entire image as a raster engraving. Any vector lines within the image will be treated as raster data and outputted as a raster engraving, similar to a dot-matrix printer.
- Vector Sorting: When performing a vector cutting job in which your image has one vector cut area enclosed within another vector cut area, select the Vector Sorting mode. This mode will automatically instruct the print driver to process the inside vector image and moving outwards. If you try to process a vector image that has multiple layers without using this mode, what may occur is the laser engraver may process the outer vector cutting first, and any inner vector cutting will not be possible as your centerpiece material may have dropped to the cutting table. This setting will always automatically direct the laser to cut from the inner most vector shape and move outwards.
- Optimization Sorting: This is a setting that will minimize your process time. When selected, the print driver will analyze your image and automatically determine the most efficient processing path to process your image.

Use Cluster (Advanced Page) [DEFAULT SETTING: Unselected]

This setting allows you to change how the Spirit GX interprets and processes individual / independent areas of an image in order to minimize job-processing times. The Cluster function is only applicable when multiple areas of an image are broken down and isolated from each other (areas not touching each other, blank space in-between). Another condition that must be met for the Cluster function is that these individual areas of your design must have some X-axis overlap, meaning that they should be to some extent side-by-side with empty spaces between them. The distance value can be set by the user and represents the limit or cutoff point in which side-by-side objects will be processed in Cluster mode or not. If the distance between side-by-side objects is greater than the set distance value, then the individual areas will be processed in Cluster mode. Conversely, if the distance between side-by-side objects is lesser than the set distance value, then the individual areas will be processed normally (not via Cluster mode).

An example of an image that would benefit from the Cluster function would be: 2 squares to be engraved, side-by-side on the X-axis with a 20 cm gap in between them. In this scenario, you would want to enable the Cluster setting and set the distance to a value less than 20. By doing so, the laser will completely process one square and “leap-frog” to the second square, rather than processing both squares simultaneously. The result: you shorten the processing time by minimizing the unnecessary travel distance the laser head needs to make across the X-axis in between squares, if they were to be processed simultaneously.

NOTE

If you wish to use the Border and Cluster function simultaneously, then the Border Thickness value must be less than the Distance value specified in the Cluster setting.

Enhanced Vector Mode (Advanced Page) [DEFAULT SETTING: Unselected]

This setting allows you to improve the cutting quality at the expense of speed. Your engraving speed will be dropped by 50%, to maximize the cutting power. We recommend that you enable this function when cutting thicker materials.

True Image Mode (Advance Page) [DEFAULT SETTING: Unselected]

This setting allows you to improve the engraving quality by reordering the line by line output sequence and by doing so masking the banding problems. This feature is only suitable for engraving large sized graphics. Note: The overall working time will be increased.

**Graphic A
With True Image**

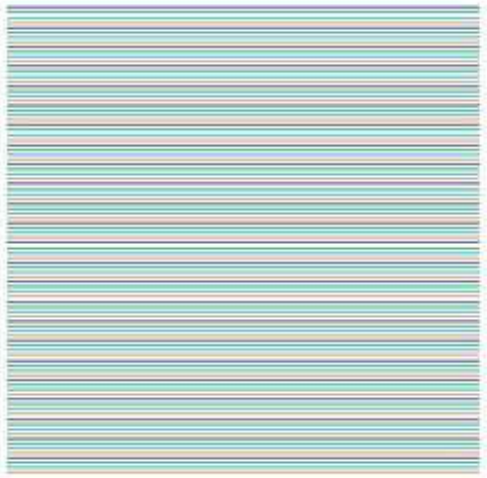

**Graphic B
W/O True Image feature**

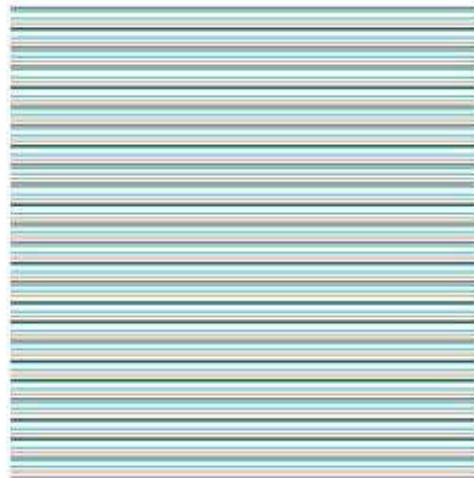

The graphic A with the True Image feature has a finer and better output performance than the graphic B without using the True Image.

NOTE

This feature can be applied to various types of material including acrylic, marble, and tile, perfect for business owners who would like to provide customized and unique product

True image function will output multiple times, it uses four layers to process a job (the job will be repeated four times). Generally, this function is used for image engraving to compensate for laser tube issues.

5.2.3.4 Spirit GX Print Driver >> Paper Page

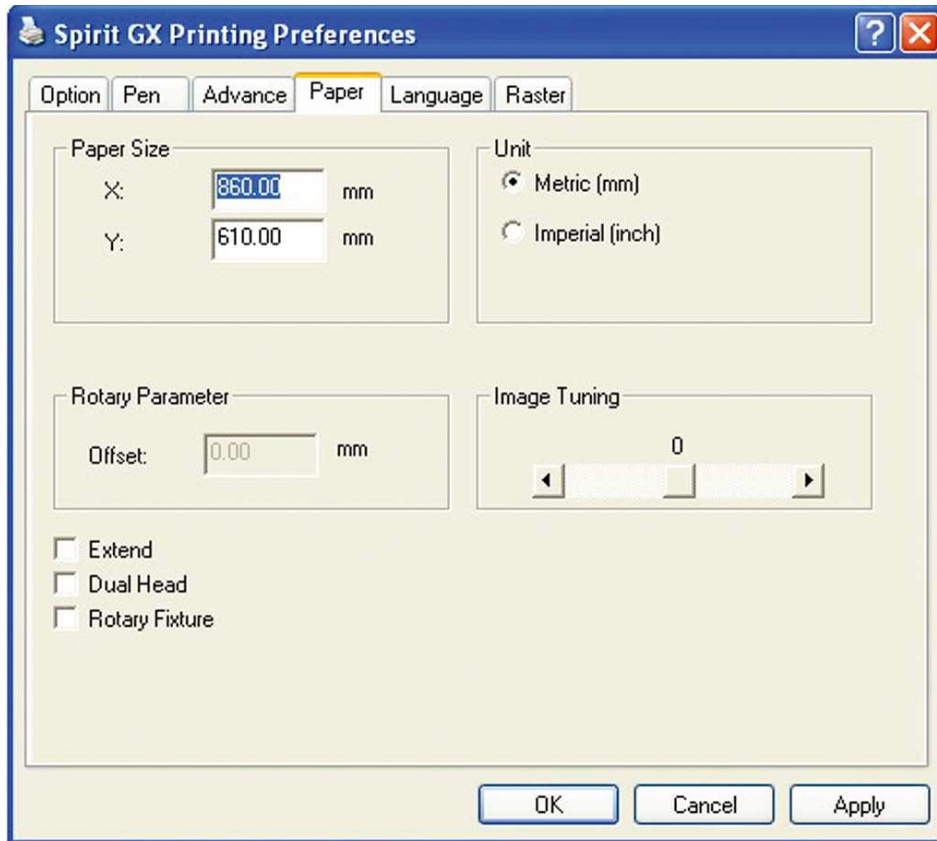

Paper Size (Paper Page)

The paper size represents your total work area. Ensure that the paper size is never set greater than the Spirit GX's work table area of 34" x 24" (860mm x 610mm) or 38" x 24" (960mm x 610mm) with the Extend option checked. The X value represents the length and the Y value represents the width.

NOTE

When using the optional rotary attachment system and with the Rotary Fixture option checked, the X value represents the length of your working piece. The Y value will be changed to Diameter, which represents the diameter of your working piece (at the position you wish to engrave).

Unit (Paper Page) [DEFAULT SETTING: Metric (mm)]

Here you can set your preferred measurement standard in which you would like to use with the Spirit GX print driver. You can choose between metric or imperial standards.

Image Tuning (Paper Page) [DEFAULT SETTING: 0]

In the event that you are processing extremely fine and detailed designs requiring near-microscopic edge-to-edge precision, you will need to adjust the image tuning setting. To adjust this setting, we recommend that you engrave a small black square design as a sample and use a magnifying glass to view the engraved results.

When you look at your engraved test square under a magnifying glass, you may notice the edges of your square may be slightly offset, with every consecutive engraved even or odd line protruding past the square's ideal edge. This occurrence may occur on the left or right side of the square and can be compensated for by the image tuning setting. In the diagram below, the arrows refer to the direction the laser head is moving to generate that engraved line. If the first and every other line protrude to the left of the square's ideal edge, you will want to set the image tuning to a negative value. If the first and every other consecutive line protrude to the right of the square's ideal edge, you will want to set the image tuning to a positive value. The further the protruding lines are from the square's ideal edge, the larger you will need to set the Image Tuning value to compensate.

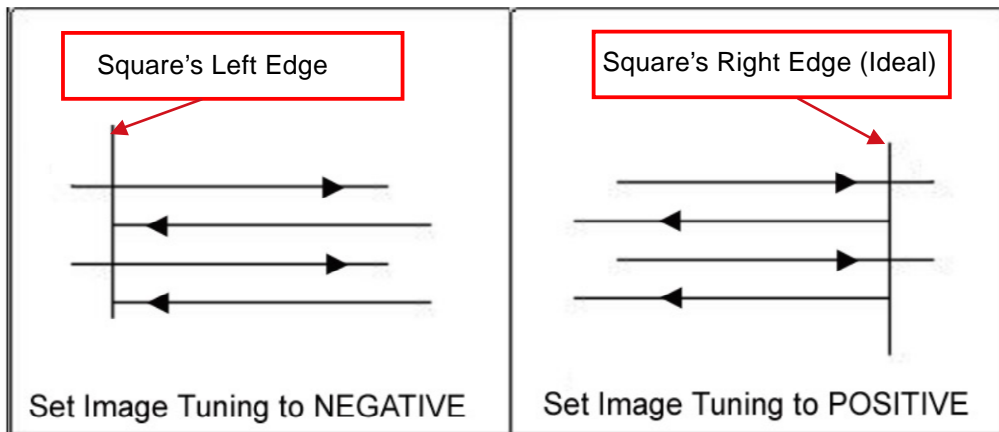

The following is an example that has the proper image tuning, and demonstrates this significance when engraving fine, small, intricate text. The following two pictures show engraved text magnified with no image tuning (left picture) and image tuning enabled (right picture).

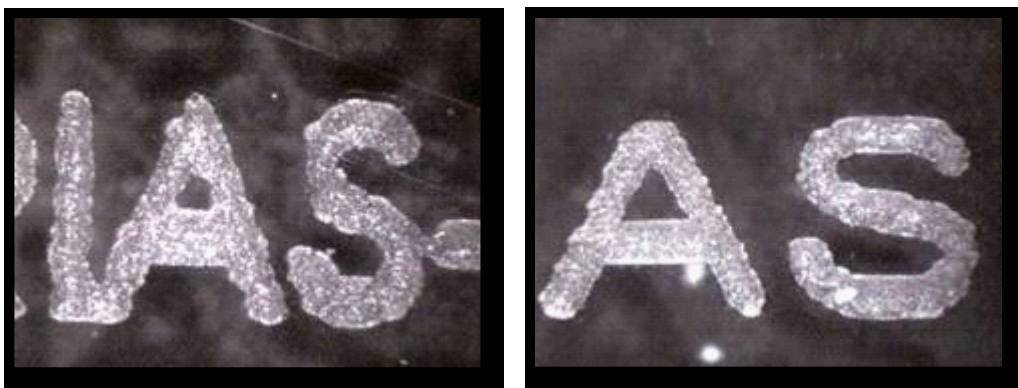

Extend (Paper Page) [DEFAULT SETTING: Unselected]

If you are processing a very large area requiring the maximum work table area, you will want to enable this mode. Enabling this mode will extend the Spirit GX's maximum work area to 38" x 24" (960mm x 610mm), from the default 34" x 24" (860 mm x 610 mm). This function is enabled at the expense of some quality loss, usually on the left and right edges of your full-size engraving. Usually the quality loss is minimal and may not be apparent, depending on your design.

NOTE

With the Extend function enabled, the following functions are disabled: 3D Mode (Options Page), Stamp Mode (Options Page), SmartACT (Options Page), Disable Skip White (Advanced), Auto Focus (Pen Page), and Rotary Fixture (Paper Page).

Rotary Fixture (Paper Page) [DEFAULT SETTING: Unselected]

NOTE

This option is only to be used with the Rotary Attachment optional accessory properly set up. For instructions on how to set up the Rotary Attachment, please refer to Chapter VII of this manual.

You will need to select this option when processing a job with the optional rotary attachment system to engrave on rounded or cylindrical objects. When you have your material and rotary attachment properly set up:

- 1) Check the Rotary Fixture function and notice the change in the Paper Size fields Under Paper Size, the X value represents the length of your work piece. Enter the length of your work piece in this field.
- 2) Under Paper Size, the Diameter value represents the diameter of your working piece (at the position you wish to engrave). Enter the diameter of your work piece in this field. Again, remember the proper diameter value would be the diameter location, at the point of engraving on your work piece.
- 3) Under Rotary Parameter, the Offset value represents distance from the open end of your work piece to the base of the padded rubber wheel. This value will be displayed on the Spirit GX's LCD panel. Enter the proper offset value in this field.

5.2.3.5 Spirit GX Print Driver >> Language Page

This page allows you to specify the language displayed by the Spirit GX Print Driver. Current language options allow for: English, Spanish, French, Chinese (Simplified, Traditional), Japanese, and German.

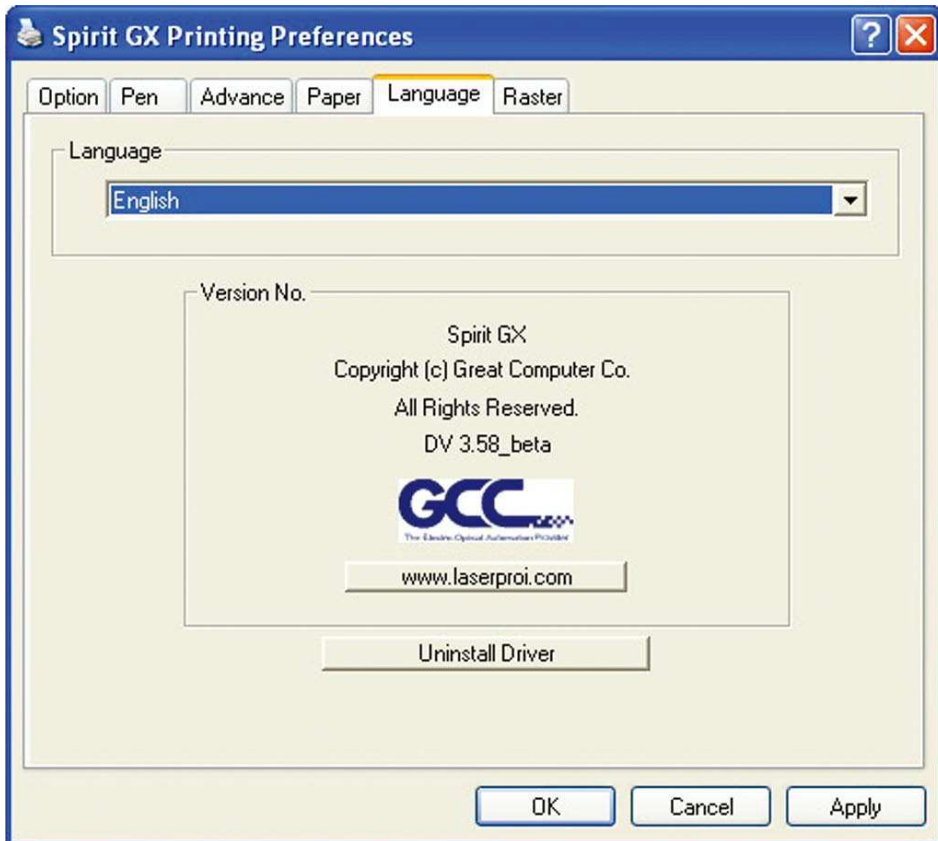

5.2.3.6 Spirit GX Print Driver >> Raster Page

NOTE

The Raster Page is only available when Black & White Mode Setting is selected from the Options Page, this page offers a number of advanced Raster Engraving output options.

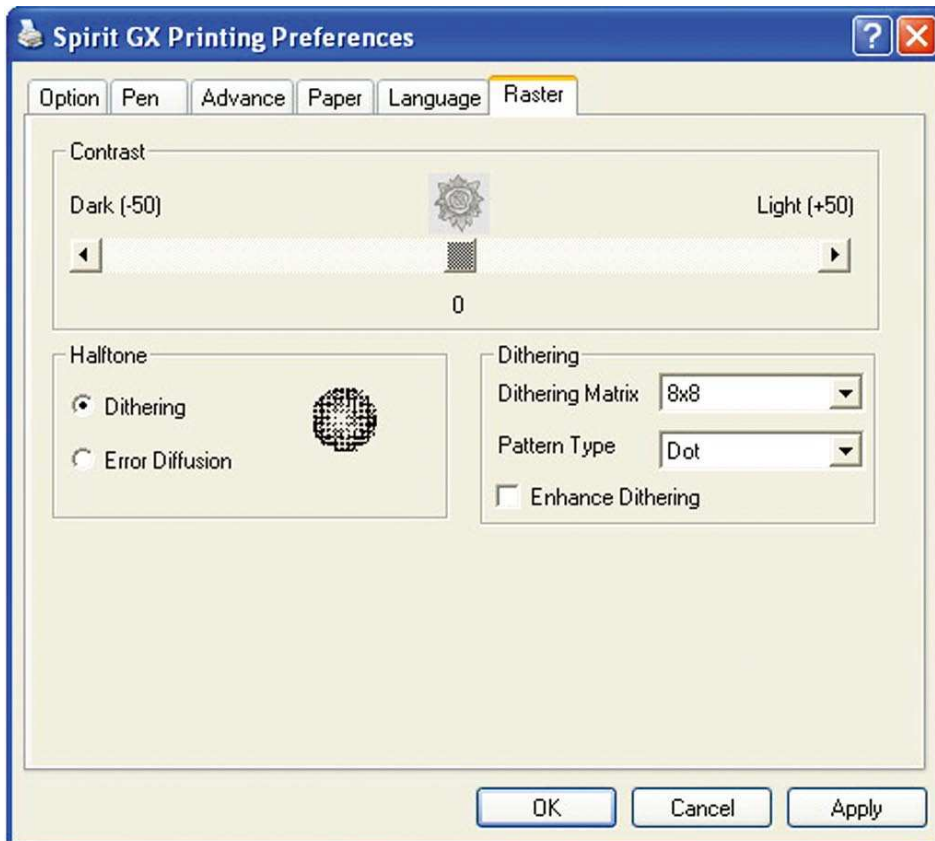

Contrast (Raster Page) [DEFAULT SETTING: 0]

This provides a quick and easy way to immediately adjust the contrast of an engraved image. Moving the slider to the Dark setting will increase the contrast levels of the engraved output, whereas moving the slider to the Light setting will decrease the contrast levels of the engraved output.



Tip

There are other ways to adjust an engraved image's contrast such as: adjust the power / speed settings or simply adjust the contrast of the image in software with the graphic software application.

Halftone (Raster Page) [DEFAULT SETTING: Dithering]

This option controls the way a raster-engraved image is processed. The "digital image to engraved output" process can be processed via two methods: Dithering or Error Diffusion. Each offer additional output options yielding different output effects, style, and quality.

- Dithering: Interprets and outputs the raster engraving via the dithering method. This mode will allow you to select the Pattern Type and Dithering Matrix, and Enhanced Dithering.
 - o **Pattern Type: Dot, Bayer, Corner, 45 Degree [DEFAULT SETTING: Dot]**
Each pattern type uses a different shape and arrangement of dots to compose the shading effect of a raster image.

The following diagram is an example of the raster effects when using the different pattern types.

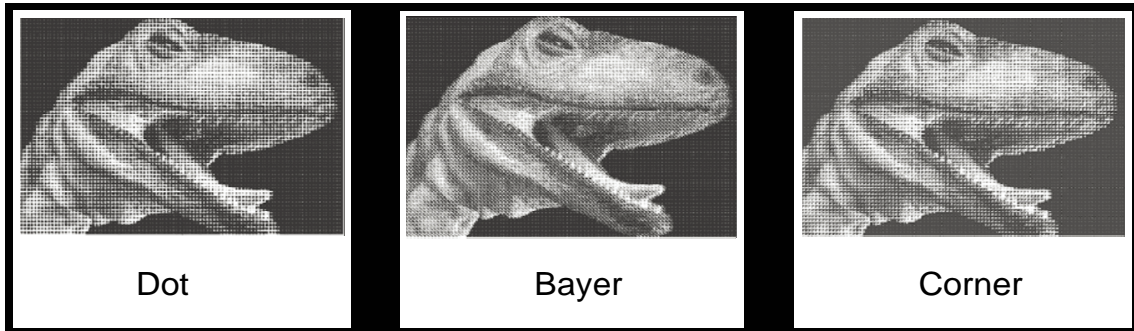

- o **Dithering Matrix: Variable depending on the Pattern Type selected. [DEFAULT SETTING: 8x8]**

This controls the resolution (dot size) and the number of dots the image is broken down into for the dithering process. As an example, selecting 2 x 2 will shade with a 5-grade halftone, where as an 8 x 8 Dithering Matrix will dither with a 65-grade halftone.

The following diagram is an example of the raster effects when using the different dithering matrices.

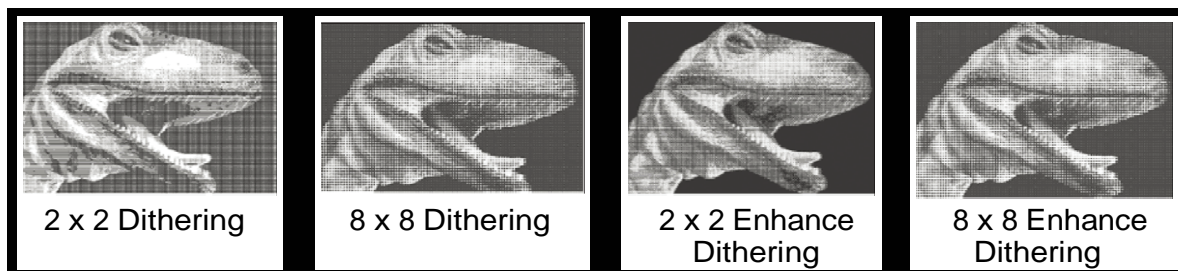

- o **Enhance Dithering [DEFAULT SETTING: Unselected]**

Selecting this will produce a finer dithering output.

- **Error Diffusion (Raster Page):** Interprets and outputs the raster engraving via the error diffusion method. This mode will allow you to select from three diffusion types: Floyd, Stucki, and Jarvis.

- o **Diffusion Type: Floyd, Stucki, Jarvis [DEFAULT SETTING: Floyd]**

Each diffusion type presents the shade of image as different spread halftones instead of dots to compose a raster image.

The following diagram is an example of the raster effects when using the different diffusion types.

**Tip**

There is no “correct” or “best” setting when using the Raster options. The most appropriate settings will be based on a variety of factors: your design, the material you are engraving on, and the results you wish to achieve, etc. Please take some time to experiment with the multitude of raster options to get the one you feel is the best for your piece. This is where much of the fun in engraving is....experimentation!

5.2.3.7 Spirit GX Print Driver >> Stamp Page

Producing stamps require different operational steps than your standard engraving or cutting jobs. The Stamp page offers dynamic options allowing you to customize your stamp production process.

NOTE

The Stamp page will only appear and be accessible when you have selected the Stamp Mode from the Options Page.



Tip

Functions located on the other pages that are useful when making a stamp: Set Shoulder, Pitch, Border, Invert, and Mirror.

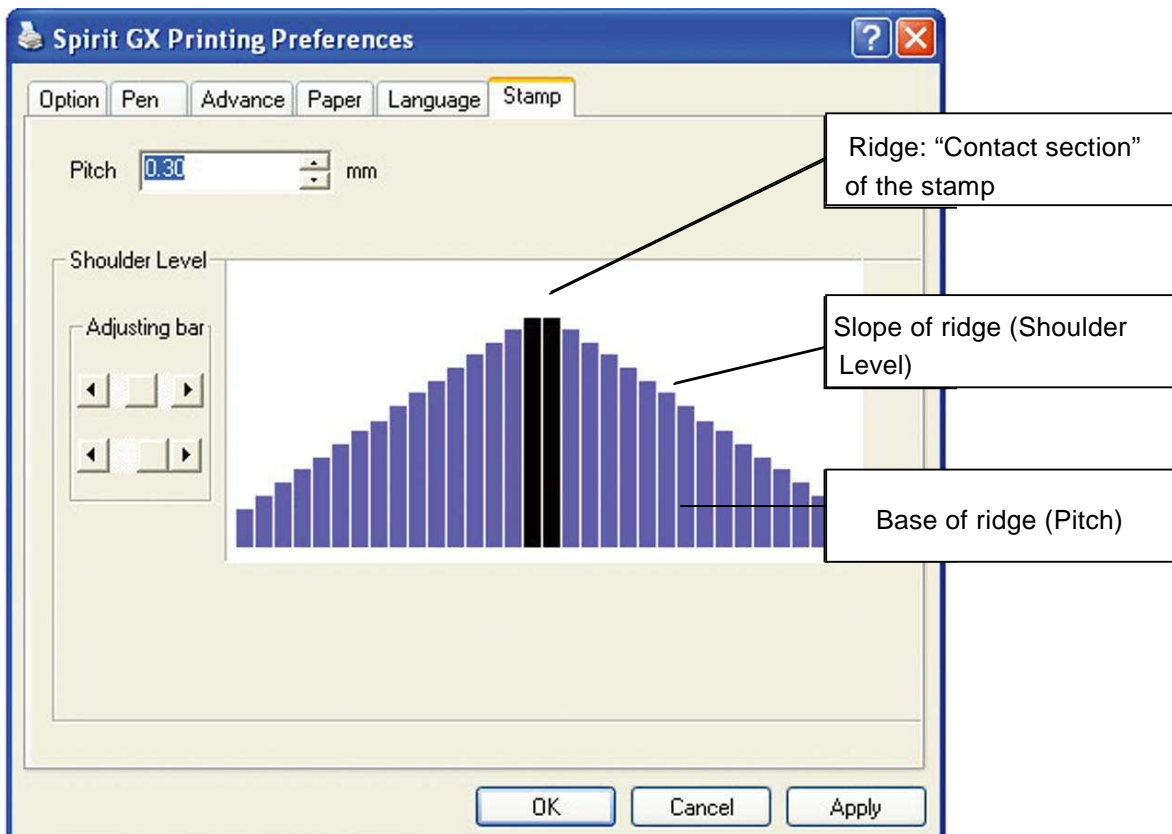

Pitch (Stamp Page)

Your stamp will be a reversed image composed of engraved depressions and ridges. Think of these ridges as the “contact sections” of the stamp. If the ridges of these contact sections are too thin, they may break. The Pitch setting allows you to increase the width of the ridge base, hence creating more stable “contact sections” and longer lasting stamp. The pitch value setting allows you to adjust the base width of the ridge. Broad pitch gives the maximum amount of support for each ridge. Experiment with different pitch value settings in order to produce the stamp that is best suited for your application.

Adjustment Bar / Power Level (Stamp Page)

Another important aspect of creating a stamp is setting the slope level of the shoulder. The shoulder is the section from the “contact section” of the stamp to its base. This function allows you to adjust the slope for the shoulder sections of your stamp. By sliding the sliders or directly input of power levels, you will be able to change the slope of the shoulder.

NOTE

The visual representations of the Pitch and Shoulder Levels in the Spirit GX driver are an exaggerated representation to allow for easy visual guidance and precise input. Remember we are working with distances less than 1 mm here.

6

Chapter 6

Engraving and Cutting Techniques

Raster Engraving

Vector Cutting

Vector and Raster

3D Tips

6.1 Raster Engraving

A laser engraver can process text, scanned image, digital picture, or design by “laser firing” grids / dots of individual pixels into a raster image. Think of this as simply “printing” your job onto any particular material.

An example of a raster engraved piece would be a photo engraving on tile, as shown in the picture below.



6.2 Vector Cutting

A laser engraver can process text, design, and images composed of lines through continuous-firing of the laser to cut out various shapes. When performing vector cutting operations, imagine the laser head as a pair of scissors cutting out the lines specified in your design. An example of a vector cut piece would be a customized dining mat, as shown in the picture below.



The Spirit GX Print Driver determines which sections should be raster engraved or vector cut based on the outline width of that particular area or section of the design. In order to prep a particular section for vector cutting, you will need to set that object’s fill color to white and set its outline thickness between 0.001" (0.025mm) to 0.004" (0.1mm) via the graphics software.

Below is an example of how to prep an area (in this case, we will use a section of text) for vector cutting. CorelDraw will be used as the selected graphics software.

- 1) With the text function, create a string of characters and select those characters by clicking on the text.
- 2) Change the text fill color of the selected characters to white by left clicking on the white color from the CorelDraw Color Palette (located on the right hand side of the screen)
- 3) Change the outline color of the selected characters outline by right clicking on the desired color from the CorelDraw Color Palette.
- 4) Change the selected characters outline thickness to the thinnest width by right clicking on the selected text →select <Properties> →Click on the <Outline> tab and change the Width to its thinnest dimension. Click on “OK” to apply the changes.
- 5) Now your string of characters has been properly designated as an area to be vector cut. Simply “print” your job (output the file to the Spirit) and watch as your string of characters is vector cut.

6.3 Vector and Raster

In some cases, you will want to process both raster engraving and vector cutting tasks within a single project. For example, if you wanted to engrave a design onto a particular material and then cut a particular shape around that engraving. The picture below is an example of engraving on a piece of cork which has then been cut out similar to a square shape:



In these situations when there are raster engraving and vector cutting operations on a single project, the LaserPro Spirit GX driver will interpret between raster sections and vector sections by the types of lines and line widths of your design. Areas of your design with line widths set between 0.001" (0.025mm), 0.004" (0.1mm) will be designated for vector cutting, and the other areas will be designated for raster engraving.

6.4 3D Tips

When doing D sample on the LaserPro Spirit GX, acrylic or MDF wood are ideal materials for the purpose. For acrylic the suggested PWR is 100%, SPD around 30% (depends on how deep you want to cut).

The perfect image for D is like those shown below. When image is ready, choose D Effect as the output mode in the driver. Sometimes, for materials such as acrylic, it would show better effect if you run the job with 2nd pass with the firing laser out-of-focus. Especially with acrylic, the 2nd pass will smooth out the surface.

For engraving wood, as it burns easily and leaves blackened surface after the 1st pass, it is necessary to run the 2nd pass to remove the burned surface. To do that, simply fill the image with black color as the mask (see below) and run the black mask image with PWR 100% and SPD 100%.

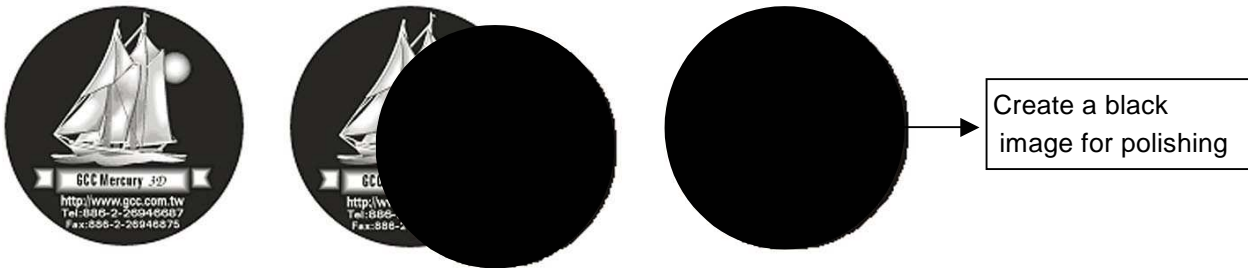

7

Chapter 7

Optional Items

Air Extraction System Option

Air Compressor Option

SmartBOX Option

SmartMEMORY Module Option

Rotary Attachment Option

SmartGUARD Fire Alarm Option

When purchasing the LaserPro Spirit GX from your local authorized GCC distributor, you will be provided with a chance to purchase optional items to enhance your experience with the acquired system. If anytime after the purchase of your Spirit GX, should you ever consider to purchase any optional item, please contact your local authorized GCC distributor.

7.1 Air Extraction System Option

To properly remove dust, vaporized materials and chemical smoke from the working area and machine, it is necessary to install a suitable air extraction system. The air extraction system and other components are readily available from your local authorized GCC distributor or you can elect to purchase and install one yourself with components found at your local industrial supply store.

LaserPro's Air Extraction Systems are specifically designed to prevent personnel from inhaling hazardous fumes and dust generated by the laser process. Available for all LaserPro engravers, the LaserPro Air Extraction System represents the latest in fume extraction and odor reduction technology for all types of applications. Quiet operation, high vacuum capacity, compact design and long life expectancy are but a few outstanding features. Each LaserPro Air Extraction System is powered by a maintenance-free, continuous-running turbine. In order to ensure personnel safety and legal compliance, the LaserPro Air Extraction System is CE-compliant for Europe and ETL-certified for the United States and Canada. To purchase a LaserPro Air Extraction System, contact your local authorized GCC distributor.

INSTALLATION (Self-Assembled Unit):

- 1) Purchase an exhaust system at your local industrial supply store, we suggest that you have a contractor install the exhaust system. We highly recommend you to install the exhaust system outside of the building for both noise considerations and if it does not possess filtering capabilities.
- 2) Mount the exhaust system in an obvious and accessible location, not too far from the Spirit GX, so it can be routinely switched on prior to laser engraving. The maximal distance you should mount the exhaust system away from the Spirit GX depends on the blower's vacuum capacity. We recommend that you consult with the vendor regarding the unit's vacuum force, maximal distances, based on the available models.
- 3) Connect rigid and smooth walled tubing such as PVC or sheet metal with a 4" diameter to the ventilation opening located on the rear side of the Spirit GX. (As shown in the picture below). Try to keep this tubing as straight as possible as bends reduce the exhaust efficiency. Use the appropriate sized tube clamps and sealants to ensure a tight and secure attachment.

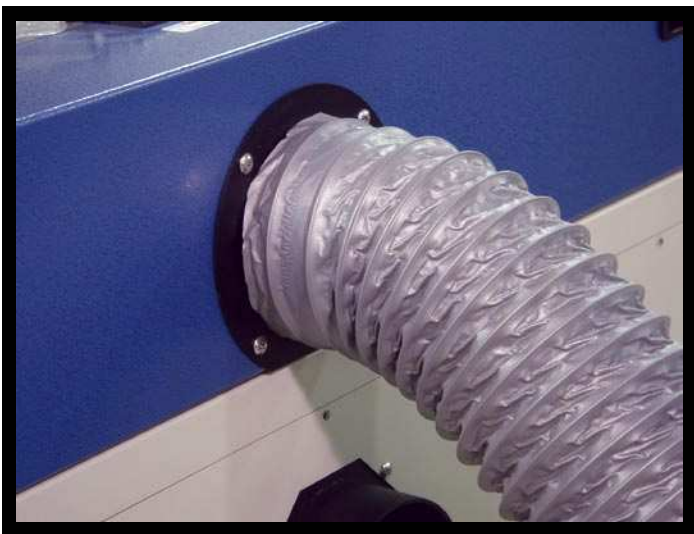

7.2 Air Compressor Optional Item

Specifically designed for laser engravers, the air compressor utilizes an oil-free diaphragm. The air compressor helps to eliminate harmful and potentially damaging moisture from the laser optics, maximizing life of the laser optics. In addition, the air compressor provides an optimal air flow to the SmartAIR nozzles to minimize flaming, suppress working temperatures, and blow away dust and particle by products generated from the laser process.

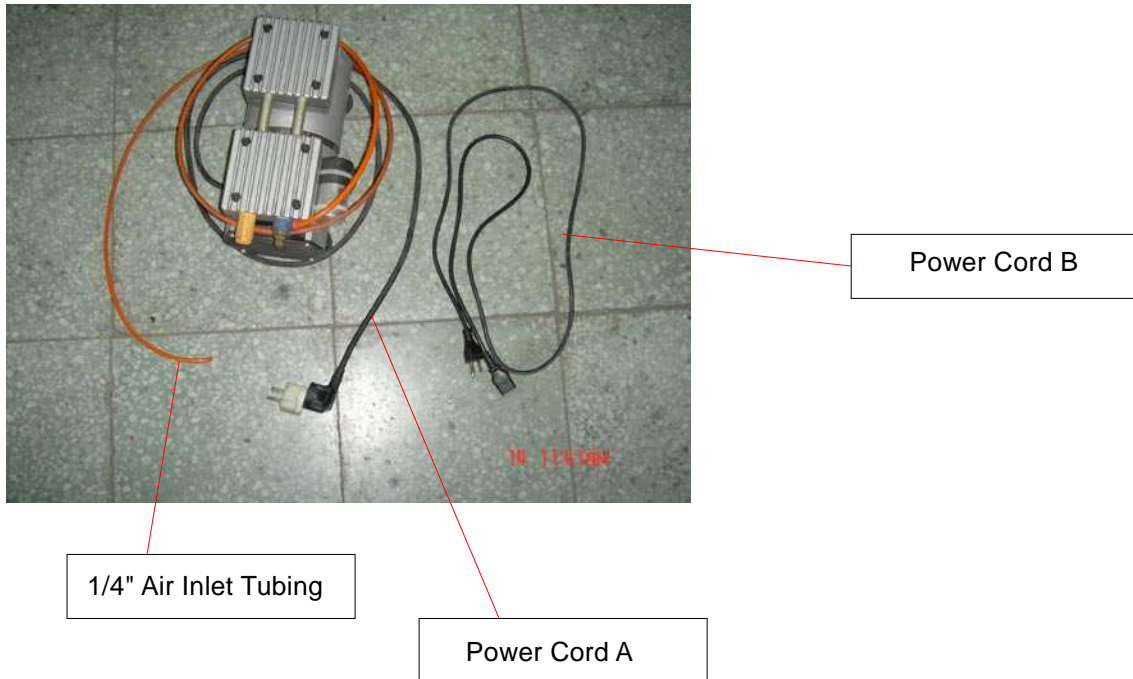

INSTALLATION:

- 1) Remove the plugs on the air compressor to expose the air inlets.
- 2) Fasten the included air tube fastener valve to the outgoing air inlet (indicated by 2a) and the air filter into the ingoing air inlet (indicated by 2b).

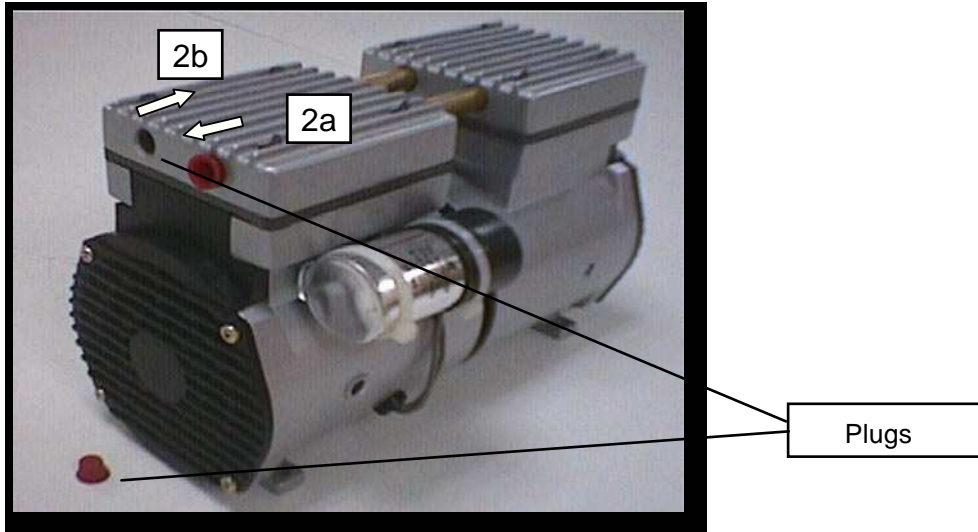

- 3) Connect a 1/4" tubing to the air tube fastener valve on the air compressor.

NOTE

It is important that the 1/4" air tubing has clean, straight cuts on each end. Jagged or slanted cuts will not produce adequate sealing capabilities.

- 4) Open the bottom doors found on the front side of the Spirit GX to locate both the Air-Assist Valve and Internal Power Sockets. As indicated below:

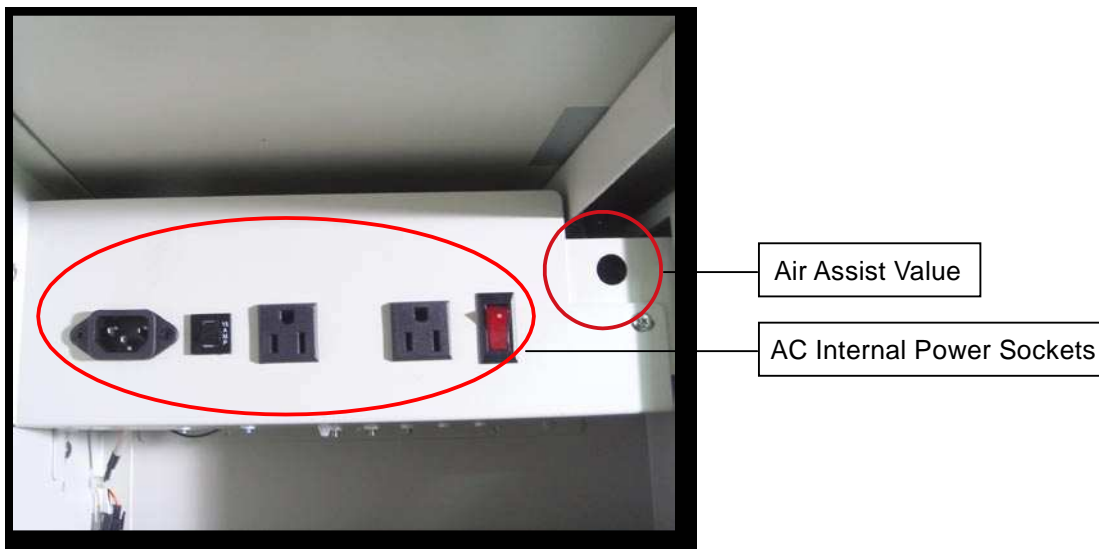

- 5) Plug the air compressor's power cord A into the AC internal power socket.
- 6) Plug the female end of power cord B to the AC internal power socket and the male end to an external power outlet.

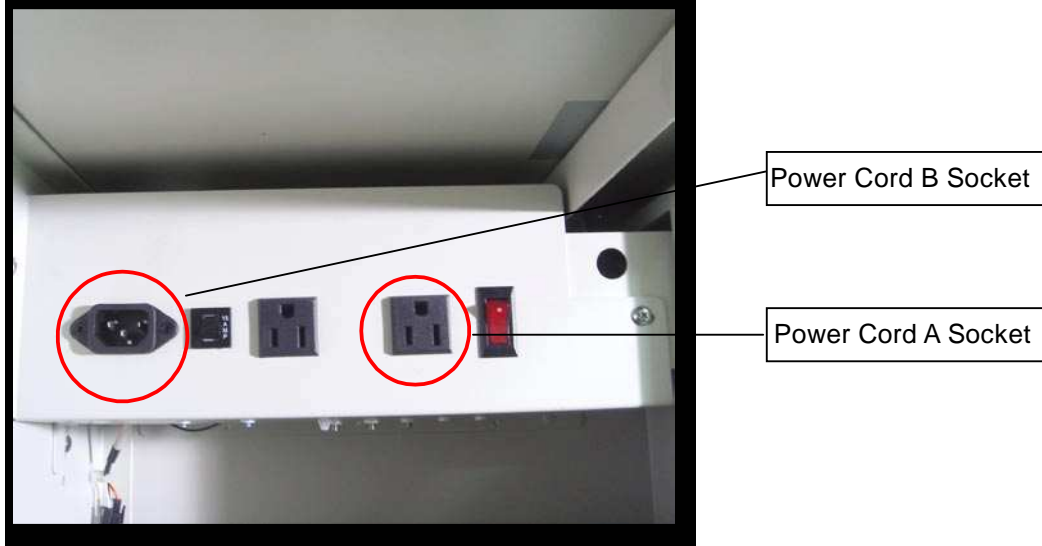

- 7) Take the unattached end of the 1/4" air tubing (other end already connected to air compressor) and connect it to the air tube connector on the air assist valve. Make sure you press down on the air tube fastener when inserting the 1/4" air tubing, to form a tight, secure attachment as indicated in the diagram below.

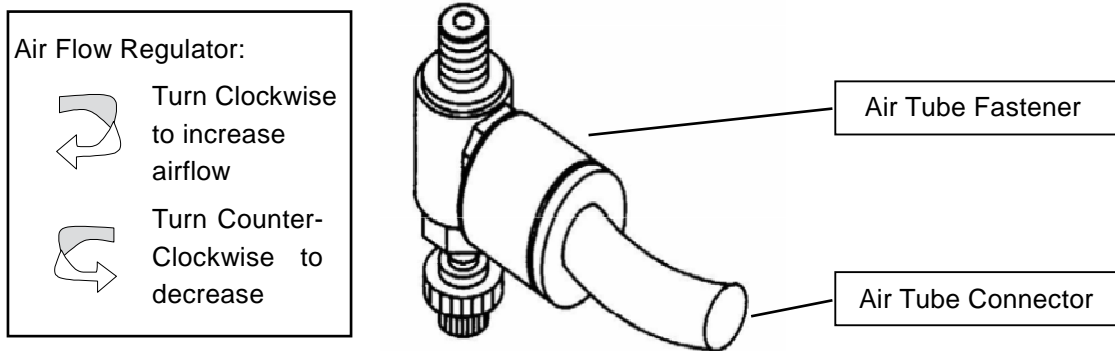

- 8) Congratulations, you have finished setting up the air compressor. Make sure you have the proper SmartAIR nozzle installed (depending on your application), before you turn on and utilize the air compressor.

OPERATION:

Switch on the air compressor unit and make sure that the airflow regulator on the air assist value is opened (turn clockwise to increase the airflow, counter-clockwise to decrease the airflow). The air nozzle under the laser head should emit a steady flow of air.

With the SmartAIR nozzle and air compressor properly installed and operating, all configurations and settings relating to air-assist functions are controlled through the LaserPro Spirit GX print driver and hardware control panel. Please refer to the LaserPro Spirit GX print driver and graphic control panel sections of this manual for details on how to enable and configure air-assist functionalities.

7.3 SmartBOX Option

The SmartBOX is an innovative combination of a cutting box, honeycomb table, and material support stands. During the cutting and engraving process, unwanted scrap, dust, and vapor byproducts are left behind. The cutting box collects the larger scrap byproducts while venting out the smaller dust particles, vapors, and smoke to minimize excess buildup on the machine, worktable, and your project. The SmartBOX allows you to maintain a clean worktable and minimizes backside burning of your media, whether you are working with thick and firm materials or thin and flexible materials.

SmartBOX Components

- **Cutting Box (a)**
- **Honeycomb Table (b)**
- **Material Support Stands (c)**
- **Thumb Screws(d)**

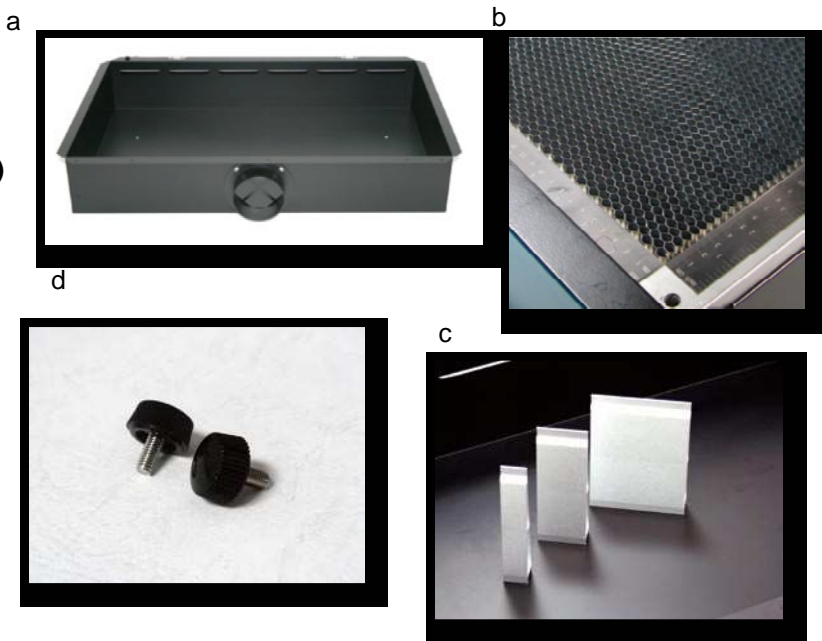

It is highly recommended that you use different setups of the SmartBOX depending on the physical properties of the material you will be working with. Here is the recommended SmartBOX component setups based on your working material.

Component Application	Cutting Box	Honeycomb Table	Material Support Stands
Thin, Flexible Materials	Required	Required	Not Required
Thick, Firm Materials	Required	Not Required	Required

NOTE

Experienced users may choose to try other component setups to suit their particular engraving / cutting techniques or working material. Feel free to explore different ways to setup the various SmartBOX components to generate results you wish to achieve.

INSTALLATION / OPERATION (Cutting Box and Honeycomb Table):

- 1) Open the front pass-through door and lower the Spirit's work table to the lowest possible position through the Spirit GX control panel.
- 2) Insert the cutting box and attached honeycomb table through the open front pass-through door onto the work table, with the air extraction opening facing towards the back end of the Spirit GX. Ensure the rear and left side of the cutting box is aligned to the edges of the left and right rulers on the work table.
- 3) Lift the honeycomb table to find the four screw holes at the bottom of the cutting box. With the included thumbscrews, secure the cutting box to the work table and close the honeycomb table.
- 4) **[OPTIONAL]** If you have an air extraction system option installed, then you will need to attach the air extraction system's pipe connector to the SmartBOX's air extraction opening from the Spirit GX's rear side. (For detailed instructions to setup the air extraction system, please see the AIR EXTRACTION UNIT section in section 7.1).

Congratulations, you are now ready to position your thin, flexible materials on top of your honeycomb table / cutting box and commence your tasks.

INSTALLATION / OPERATION (Cutting Box and Material Support Stands):

- 1) In order to use the cutting box along with the material support stands, you must first remove the honeycomb table from the cutting box. Before you position the cutting box in the Spirit GX, first loosen the screws that attach the hinges of the honeycomb table to the cutting box.
- 2) Remove the honeycomb table. Please keep in mind the honeycomb table surface is fragile; therefore, it is suggested to keep it in a safe place.
- 3) Open the front pass-through door and lower the Spirit GX's work table to the lowest possible position through the Spirit GX control panel.
- 4) Insert the cutting box through the open front pass-through door and place it onto the work table, with the air extraction opening facing towards the back end of the Spirit GX. Ensure the rear and lefthand side of the cutting box is aligned to the edges of the left and right rulers on the work table.
- 5) Find the four screw holes at the bottom of the cutting box. With the included thumbscrews, secure the cutting box to the work table.
- 6) On the front right hand side of the cutting table, there will be a metal guard, which must be swiveled so that it is perpendicular to the front side of the cutting table (as shown in the picture below). This allows the Spirit GX to properly account for the extra height the cutting table which adds to the cutting table.

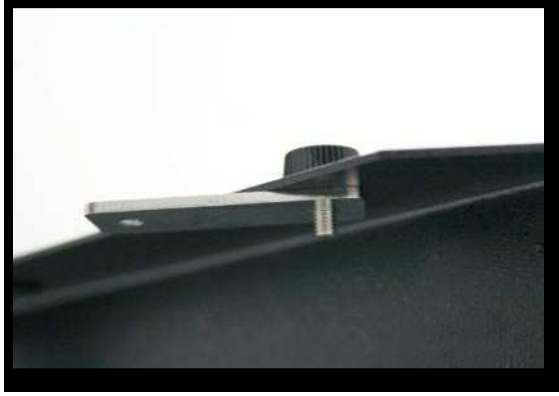

⚠ CAUTION

Damage may occur to the system if you try to raise the work table without proper setting of the metal guard.

- 7) Now position the included material support stands so they support the thick, firm material you will be working with, while avoiding the laser path. In other words, avoid placing the support stands underneath any section of the material that will be lasered, especially during laser cutting.

7.4 SmartMEMORY Module Option

The SmartMEMORY module option increases productivity and efficiency by allowing you to save and load unfinished tasks, without having to retransmit task settings from the computer again. It enables users to save and load working files to and from the Spirit GX. In addition, the SmartMEMORY module is portable and can be used to transfer task settings from one machine to another.

INSTALLATION:

⚠ CAUTION

It is highly recommended you completely turn off the Spirit GX and unplug its cord from the power source before installing or removing the SmartMEMORY module.

- 1) To install the SmartMEMORY module, you will need to first access the system's motherboard. To do so, use a screwdriver to remove the two screws securing the panel on the right hand side of the Spirit GX.
- 2) Open the panel and to expose the Spirit GX's motherboard.
- 3) Simply connect the SmartMEMORY module to the connector on the Spirit GX's motherboard (indicated in the pictures below).

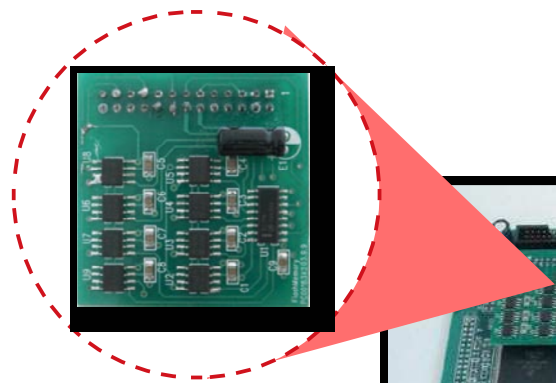

SmartMEMORY Module

Spirit GX's Motherboard



OPERATION:

With the SmartMEMORY module installed, you will be able to SAVE to and LOAD from the SmartMEMORY :

NOTE
In order to properly use the SmartMEMORY module with the Spirit GX, please ensure the Spirit GX's firmware is version 1.02 or later. Also keep in mind, the capacity of the SmartMEMORY module is 4MB, please do not save files that exceed this limit.

SAVE files to the SmartMEMORY module:

- 1) Navigate to the Write to Memory function. From the Spirit GX Control Panel, press F4 (Function) MACHINE SETTING (SmartMEMORY (Save to SmartMEMORY.
- 2) By selecting the Write Flash Memory function, the tasks stored on the Spirit GX will be transferred over to the SmartMEMORY module.

LOAD files from the SmartMEMORY module:

- 1) Navigate to the Load from Memory function. From the SPIRIT GX Control Panel, press F4 (Function) MACHINE SETTING → SmartMEMORY → READ SmartMEMORY.
- 2) By selecting the Read from Memory function, the tasks stored on the SmartMEMORY module will be transferred over to the machine.

7.5 Rotary Attachment Option

The rotary attachment option provides the Spirit GX with the ability to engrave on cylindrical or spherical objects. In addition to the standard X, Y, Z axis, the rotary attachment allows for a fourth axis which rotates your object 360° to allow for engraving on cups, wine glasses, and even balls.

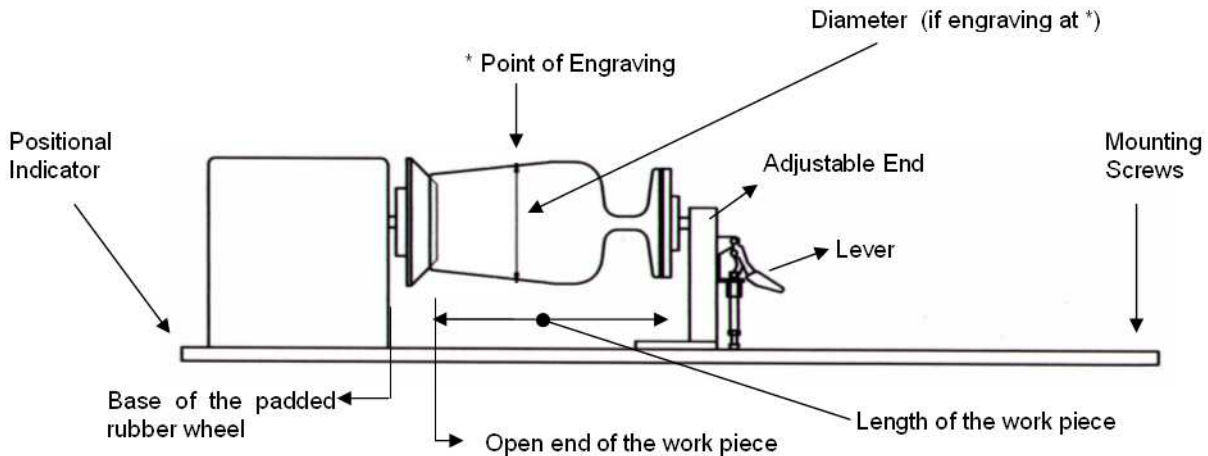

Work Piece Limitations	
Maximum Length	450 mm (17.71 inches)
Maximum Loading Weight	7 kg (15 lbs.)
Minimum Diameter	90 mm (3.54 inches)
Maximum Diameter	180 mm (7.09 inches)

INSTALLATION:

- 1) Turn off the power of the engraver.
- 2) Set the rotary attachment onto the engraving table so that the bottom mounting screws correspond to the positional holes on the engraving table. In addition, the top end of the rotary attachment must be leveled against the engraving table with the rotary's positional indicator (center point of the top of the rotary attachment) aligned to the center position on the engraver's vertical axis.
- 3) With the rotary attachment properly positioned, tighten the mounting screws to secure the rotary attachment.
- 4) Open the front panel of the Spirit GX and connect the rotary attachment cable to the rotary attachment port located inside the Spirit GX's front panel (shown in the picture below).

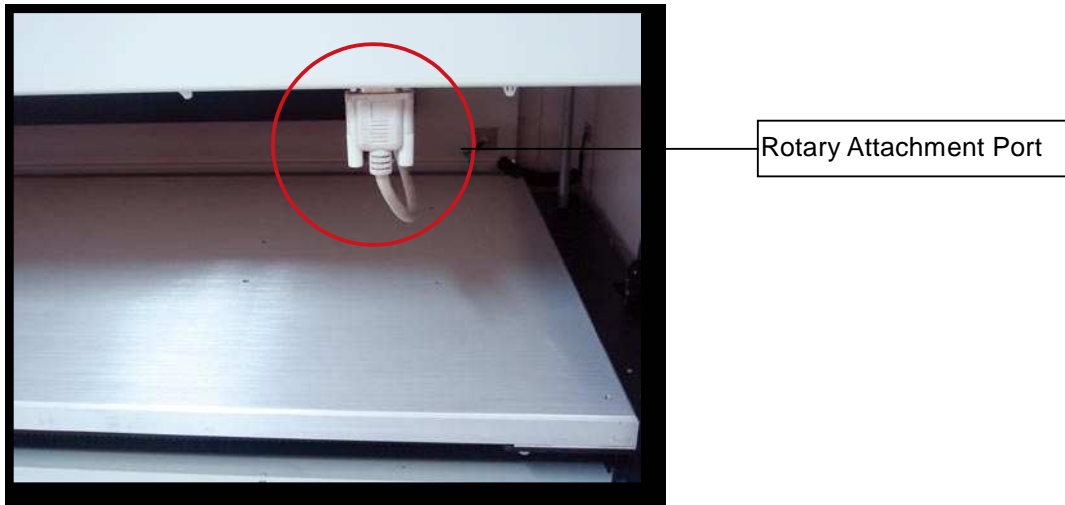

- 5) Close the front panel.
- 6) The rotary attachment is now properly installed. Power on the Spirit GX and the rotary attachment will be automatically detected and the engraving table will automatically move to its lowest position.

OPERATION:

- 1) Use a ruler to measure the diameter (at the point on the work piece you will be engraving) and length of the work piece you will be engraving. Make a record of this.
- 2) Load the work piece onto the rotary attachment by first listing the lever on the rotary attachment, unlocking the adjustable end of the rotary attachment. Slide the adjustable end to accommodate the length of the work piece. Load the working piece by centering the open end of the work piece against the rubber wheel and slide the adjustable end to fit the bottom of work piece firmly. Now simply lower the lever to secure the work piece with the rotary attachment.

 **CAUTION**

If your work piece is small, please apply 4" focal lens for operation to prevent the lens carriage from colliding with the rotary attachment.

- 3) Prepare the graphic you would like to engrave with the rotary attachment and go to the Paper Page of the Spirit GX print driver.

NOTE

Please refer to section 5.2 of the reference manual for complete instructions on how to use the Spirit GX's Print Properties.

- 4) From the Paper Page, the first thing you must do is to check the Rotary Fixture. The Paper Size options and Rotary Parameter will change to allow for proper input based on your rotary attachment.

- a) Under Paper Size, the X value represents the length of your working piece. Enter the length of your work piece in this field.
 - b) Under Paper Size, the Diameter value represents the diameter of your working piece (at the position you wish to engrave). Enter the diameter of your work piece in this field. Again remember the proper diameter value would be the diameter location on your work piece you will be engraving.
 - c) Under Rotary Parameter, the Offset value represents distance from the open end of your work piece to the base of the padded rubber wheel. This value will be displayed on the Spirit's LCD panel. Enter the proper offset value in this field.
- 5) Your Spirit GX print driver settings are now properly set. Manually position the laser carriage to the proper X / Y location on the object you will be engraving and position the auto focus pin over the area to be engraved on your work piece. Hit the Auto Focus button and the Spirit GX will now properly focus at the location to be engraved.
 - 6) Go back to the Spirit GX Print Driver to print your design and let the engraving begin.

NOTE

The maximum diameter and length of the to-be-engraved object is 90mm and 450mm respectively. Its maximum weight should not exceed 7kg.

7.6 SmartGUARD fire alarm Option

Laser cutting and engraving operations using the SmartGUARD device protects the operator, machine, produced and the work products from potential fire hazards. During the engraving process, flames may be produced when working with combustible or easily-flammable materials, such as paper or wood. The SmartGUARD is an optional item that can be set to notify the operator through audio warnings and automatically shutdown the machine as a safety precaution.

INSTALLATION:

If you have purchased your system with SmartGUARD, then no installation is required, as your system will arrive with SmartGUARD pre-installed.

For system owners that did not initially purchase this option, but would now like to add the SmartGUARD, they will need to contact your local authorized GCC distributor to have this great feature installed.

1. Lift the SmartLID using the handles.

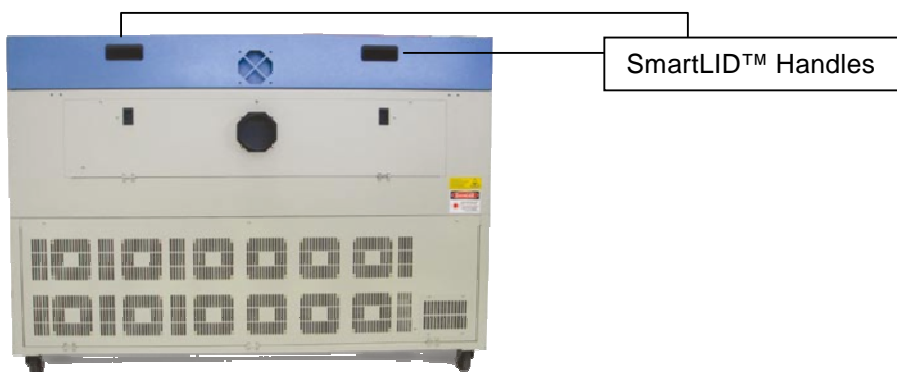

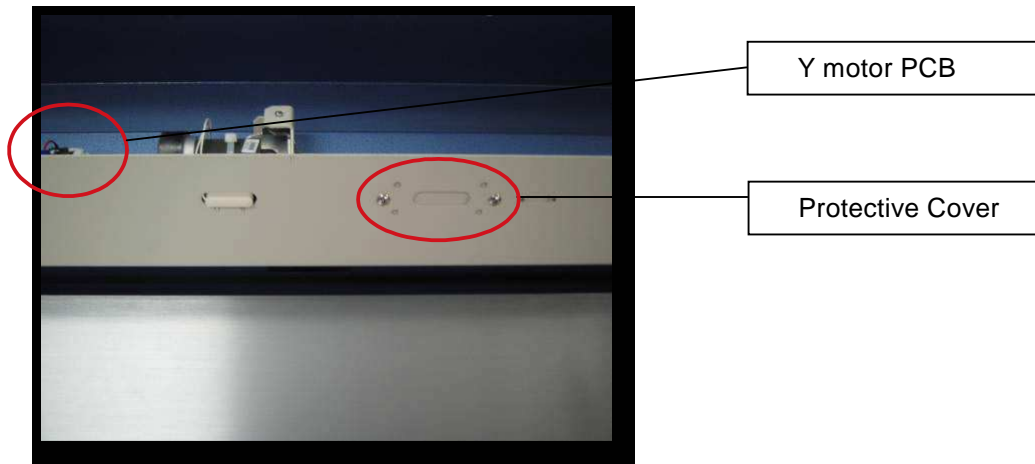

2. Remove the protective cover

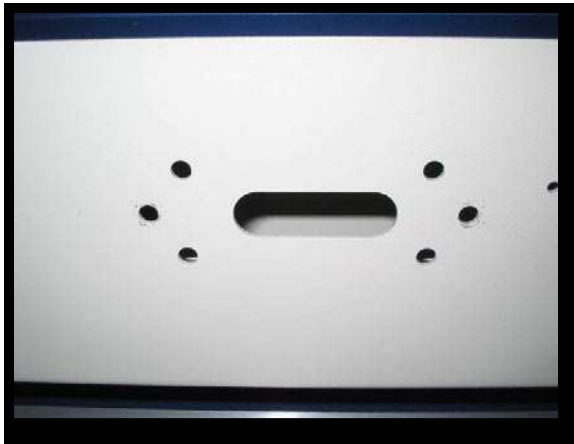

3. Fix the SmartGUARD on the reserved place.



Front View



Top View

4. Connect the wire from the SmartGUARD sensor board to the Y motor PCB.

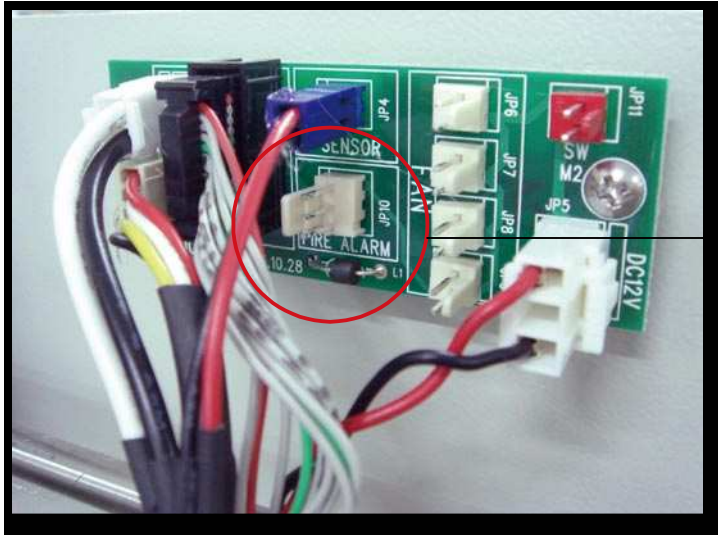

The SmartGUARD 3-pin signal jumper is positioned under the blue connector of the Y motor PCB

5. Gently cover the SmartLID.

OPERATION MENU:

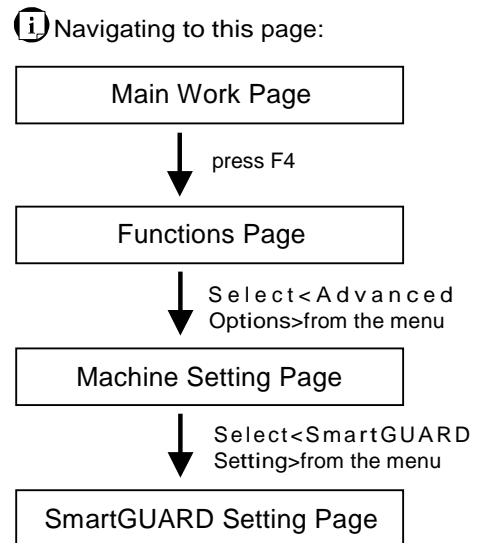
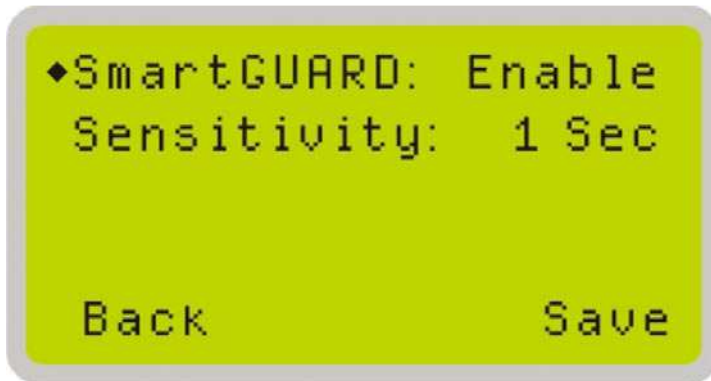

After hardware installation, please enter the function menu on the control panel to enable the SmartGUARD fire alarm.

SmartGUARD Enable / Disable:

Press directional key (left or right) to enable the SmartGUARD device or disable it.

Sensitivity:

Press directional key (left or right) to set the sensitivity of SmartGUARD. There are five sensitivity settings (1,3,5,7,9 seconds) that can be selected. Sensitivity is defined by the delay time from when a fire is detected until the fire alarm alerts user of fire and automatically shuts down the system. For example, if the sensor delays switch is set to the 3 second position, the SmartGUARD will start an alarm and automatically shutdown the laser system after detecting a fire for 3 seconds.

SmartGUARD Setting Page	
Relevant Buttons	Function
F1 (Back)	Back to previous page
F4 (Save)	Save your current settings
△ / ▽ Directional	Adjust the value for that selection
◀ / ▶ Directional	Scroll through the menu selections

8

Chapter 8

Basic Maintenance

Suggested Cleaning and Maintenance Supplies

Maintaining the Work table and Motion System

- Accessing the Work table and Motion System
- Cleaning the Work table and Motion System
- Lubrication of the Y Rails

Cleaning the Optics System

- Removing the Mirrors
- Cleaning the Mirrors
- Removing and Cleaning the Focal Lens

Keeping your LaserPro Spirit GX clean and well maintained will ensure quality output, consistent reliability, and extended product life. Smoke, dust or residue build-up inside the laser system or the mechanical components can cause a reduction in the laser power, irregularities in the motion system, reduced product life cycle, and a host of other avoidable problems. This section will cover how to perform regular maintenance on the Spirit's work table, motion system, mirrors, and focal lens.

The frequency of the cleaning schedule will depend on number of variables such as the types of material you work with, the immediate work environment, the frequency of use, the quality of the exhaust system, etc.

 WARNING	
<ul style="list-style-type: none"> Electrical shock may occur if you do not turn off and unplug the Spirit GX before cleaning. Damage may occur to the system if you do not turn off and unplug the Spirit GX before cleaning. Always turn off and unplug the Spirit GX before cleaning! 	

8.1 Suggested Cleaning and Maintenance Supplies

Cleaning / Maintenance Tool	Special notes
Soap Solution or All-Purpose Cleaner	
Paper Towels	
Cotton Cloth	
Denatured Alcohol	DO NOT use alcohol on any painted surface, plastic, or the laser system.
Acetone	ONLY to be used on the work table
Vacuum Cleaner with a Flexible Nozzle	Only to be used in and around the work table and motion system
Light Grade Machine Oil	
Cotton Swabs	Supplied
Lens Cleaner	Supplied
Lint Free Lens Tissue	Supplied
#2 Phillips Screwdriver	
Allen Wrench .050"	

8.2 Maintaining the Work table and Motion System

8.2.1 Accessing the Work Table and Motion System

It will be important to gain full access to the work table and motion system to properly clean and maintain these areas. To do so, you will need to open the LaserPro Spirit GX's SmartLID. You can do this via the following steps:

Opening the SmartLID:

- 1) The top lid of the machine can be lifted open by using the handles from the rear side of the LaserPro Spirit GX. Lift the lid to the maximum (indicated by a small click) to engage the latch (as shown in the picture below).



- 2) Manually lock the SmartLID via the two sliding locks found on each side of the metal support rails by sliding them to the locked position (as shown in the picture below).

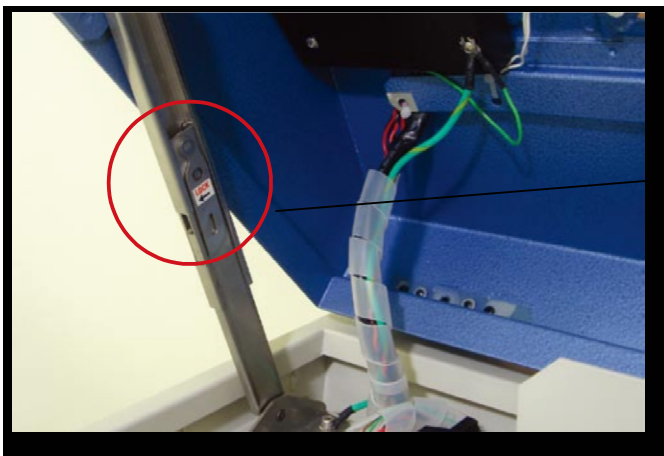

SmartLID Sliding Lock



WARNING

Anytime you have the SmartLID open, always make sure you have properly engaged the SmartLID manual locks on both sides of the metal support rails. Failure to do so may pose a serious risk if the SmartLID slams down.

Closing the SmartLID:

To properly close the SmartLID after you have finished accessing the work table or motion system, please follow these steps:

- 1) Disengage both of the sliding locks found on each side of the metal support rails by sliding them away from you and into the unlock position.
- 2) Push the SmartLID away from you and move to the maximum position to disengage the latch (indicated by a small click) and gently close the SmartLID.

8.2.2 Cleaning the Work Table and Motion System

Clean the working table and the motion system on a frequent basis through the following steps:

- 1) Turn the power off and unplug the Spirit GX before cleaning.
- 2) Use a vacuum cleaner with a flexible nozzle to remove dust and debris from the work table and motion system.
- 3) Apply small amounts of all-purpose cleaner, alcohol, or acetone to a paper or cotton towel to clean the working table.
- 4) Apply a soap solution, all-purpose cleaner, or alcohol to a paper or cotton towel to wipe down the rails of the motion system.
- 5) Wait for all cleaning residue to dry completely before plugging in and operating the Spirit GX.



CAUTION

- Never pour or spray alcohol or acetone directly to the work table.
- Oil, alcohol and acetone can cause fires or smoke build-up if improperly used.

Tip: Please clean the Auto Focus pin each time after completing the engraved job to make sure the Auto Focus pin is free to move.

8.2.3 Lubrication of the Y Rails

In order to keep the motion system running smoothly, the Y rails of the motion system will need lubrication on a semi-regular basis. Use a small amount of light grade machine oil or PS2 grease on a paper or cotton towel and apply to the rails.

You can purchase PS2 grease from NSK dealers worldwide. Please visit <http://www.nsk.com/eng/company/network/index.html> for additional information.

NOTE

- Always clean and lubricate the rails after working with materials that produce lots of debris (such as wood).
- Too much oil or PS2 grease applied to the Y rails will accelerate the build up of debris.

8.3 Cleaning the Optics System

8.3.1 Removing the Mirrors

We recommend that you check the mirrors once or twice a week to see if they require cleaning. If any debris or smoke residue is present, use the following steps to clean them.

NOTE

- Mirrors should be removed for cleaning one at a time to avoid beam misalignment after placing them back to the lens holders.
- Refer to section 8.3.2 on how to clean the mirrors.

The following section will illustrate the location of the four mirrors found on the LaserPro Spirit GX for cleaning.

Mirror 1

This mirror is located inside the bottom left access panel of the LaserPro Spirit GX.

- 1) Use a #2 Phillips Screwdriver to remove the access panel located on the bottom left side of the LaserPro Spirit GX.
- 2) Loosen the thumbscrew and remove the dust cover.
- 3) Loosen the thumbscrew securing mirror 1. (As shown in the picture below).

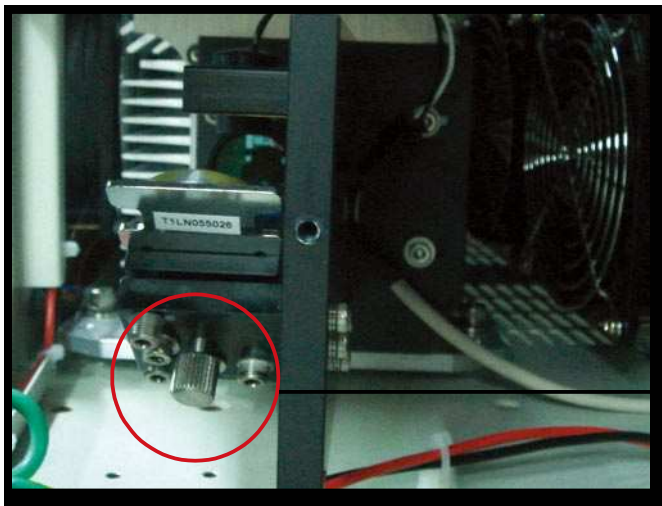

Thumbscrew

- 4) Clean the lens in the proper manner.
- 5) Place the mirror back to the optics holder after cleaning.
- 6) Tighten the thumbscrew.
- 7) Replace and secure the outer access panel.

Mirror 2, 3, 4

These mirrors are located in the work table area of the LaserPro Spirit GX.

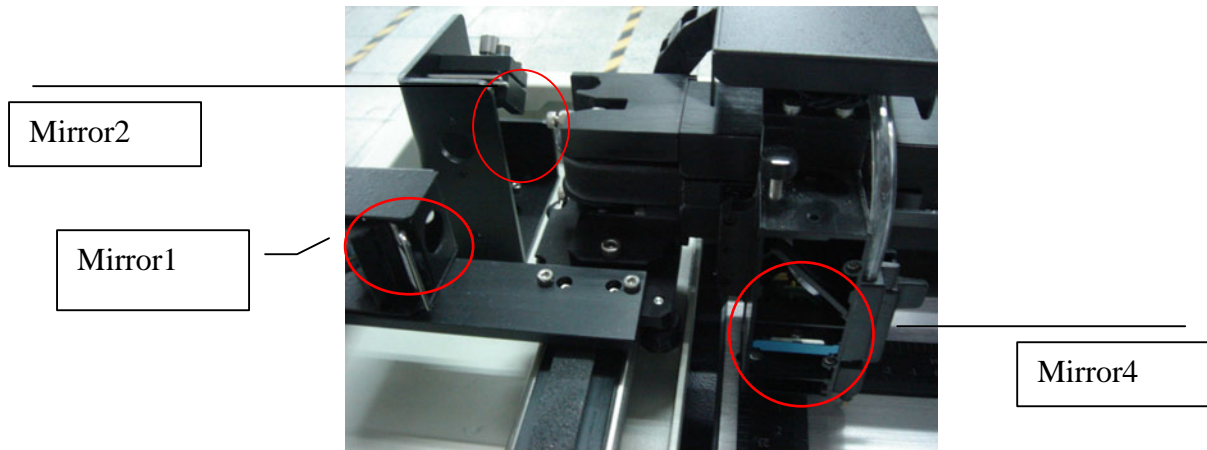

Mirror 2

- 1) Unscrew and remove the black dust cover covering mirror 2.
- 2) Unscrew the thumbscrew holding mirror 2 in place.
- 3) Clean the lens in the proper manner.
- 4) Place the mirror back to the optics holder after cleaning.
- 5) Tighten the thumbscrew.
- 6) Replace and secure the black dust cover.

Mirror 3

- 1) Unscrew the thumbscrew holding mirror 3 in place.
- 2) Clean the lens in the proper manner.
- 3) Place the mirror back to the optics holder after cleaning.
- 4) Tighten the thumbscrew.

Mirror 4

- 1) Unscrew the three thumbscrews securing the laser carriage panel and remove the laser carriage panel to reveal mirror 4 and the focal lens.
- 2) Loosen the top thumbscrew to remove mirror 4 (as shown in the picture below).

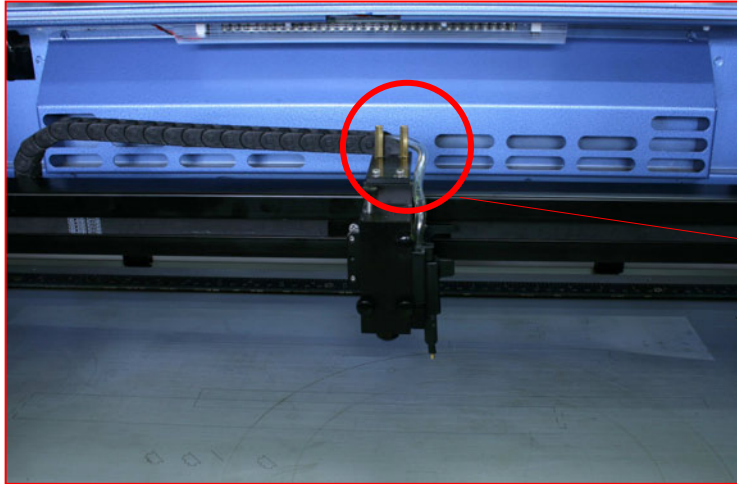

Top Thumbscrew

- 3) Clean the lens in the proper manner.
- 4) Place the mirror back to the optics holder after cleaning.
- 5) Tighten the top thumbscrew.
- 6) Reinstall the laser carriage panel and tighten the three thumbscrews.

8.3.2 Cleaning the Mirrors

After you have removed each mirror, you will want to inspect each mirror for scratches, smoke residue, or debris. If any residue or debris is present, use the following steps to clean the mirrors.

- 1) Hold the mirror with the reflective side up, without touching the reflective side of the mirror (DO NOT apply any finger pressure or any other cleaning solutions to the mirror surface).
- 2) Drape a new sheet of lens tissue over the mirror.
- 3) Apply a few drops of lens cleaner on the tissue covered mirror (apply enough so that the tissue absorbs just enough solution to cover the mirror surface).
- 4) Pull the tissue across the mirror in only one direction.
- 5) Repeat the cleaning processes if the mirror is not completely clean after the first attempt.
- 6) Make sure that the mirror is completely dry before reinstalling it.



**CAUTION**

If the center of the mirror is scratched, contact your LaserPro Spirit GX dealer for a replacement.

8.3.3 Removing and Cleaning the Focal Lens

- 1) Unscrew the three thumbscrews securing the laser carriage panel and remove the laser carriage panel to reveal the focal lens.
- 2) Carefully pull out the focal lens.
- 3) Clean the focal lens with a cotton swab and lens cleaner solution. Be sure to clean both sides of the focal lens (DO NOT apply any finger pressure or other cleaning solutions to the lens surface).
- 4) After cleaning, use a cotton swab to gently dry the focal lens and lens cover.

9

Chapter 9

Basic Troubleshooting

Quality Problems

- Check focal length setting under F4 function key → Machine Setting → Set Focus Lens to see if it matches the type of the lens installed.
- Check if the focal lens is installed correctly or if focal lens is not fixed properly.
- Check if it is caused by the debris or dust builds up in the bearing tracks of X rail.
- Check if it is caused from the damaged or dirty focal lens and mirror 4 in the laser carriage which can not deliver the laser beam effectively.

Non-operational Problems

- **Laser does not fire**

1. If the red alignment beam is not visible, the laser beam may be misaligned. Adjust the reflection mirrors for exact focus.
2. If the red alignment beam is visible, please check the driver power. The laser power may be set to too low for detection. Increase the percentage setting of the Laser Power from the software driver or the control panel.
3. Check if the laser power connector is connected.
4. For safety purposes, the laser will not fire when the top lid or the front door is open unless the door sensors are defeated by shorting them with magnets.
5. Check water level or temperature of water cooler if the equipped laser requires water cooling. The laser tube will automatically shut down itself if the laser tube is over-heated.

NOTE

Unplug the machine before examining the mirrors, lens, motion system or any other part of the laser system.

Other Problems

- "Graphic Was Clipped..." Message

The size or location of graphic image may be bigger or beyond the legal working area. Do not place graphic object, especially vectors, right from (3,0) origin position, or 0 at either x or y rail of working area on application software. Take Corel Draw for instance, even when the vector line's width has been set to the thinnest, it may still go beyond the border and causes the error. If the message appears randomly but frequently even image object is smaller or within the legal border, check or change DRAM module, a bad contact or faulty DRAM could cause such error.

- Auto Focus Pin is Not Functioning

The focus pin could be stocked by greasy residue that gradually forms a coating. Clean the probe with alcohol or acetone. Check the cable of focus pin, there might be a bad contact or breakage.

10

Chapter 10

Appendix

Glossary

LaserPro Spirit GX Specification Sheet

10.1 Glossary

Color Fill – Term within the awards and engraving industry used to describe the variety of techniques used to add color or contrast to engraving.

DPI – Dots Per Inch or Pixels Per Inch. The resolution of an image is defined by the amount of dots/pixels included in an inch. The DPI setting of 500, will tell the machine to include 500 laser firings within an inch.

Driver – A software program that allows the computer to communicate with its components and peripherals: printers, scanners, monitors, etc.

Error Diffusion (Dithering Method) - This effect uses a series of random black and white pixels to represent shading.

Firmware – Programming permanently set into a computer's ROM chips. This information is burned into the computer chips and can only be changed by replacing the chips, or in the case of EEROM, by special procedure.

Parallel Cable – The cable connection between the computer and another device (usually the printer). This allows the computer to send several bits of data simultaneously.

Parallel Port – An outlet on your computer or electronic device that allows the computer and device to be connected and share information simultaneously. Another common name for the parallel port is the LPT port.

PPI – Pulses Per Inch. PPI determines the gross amount of laser pulses there will be per linear inch. PPI is exclusively used for the vector setting. A PPI setting of 500 results in the laser firing every .002" (500 times per inch). If the standard lens is producing a vector laser focal point of .007", then higher

PPI settings will result in deeper, overlapping laser pulses. PPI settings lower than 150 will result in the individual laser pulses being spread far apart, so they will not touch each other. Low PPI settings are a good example of perforate paper.

Raster – The process of rendering a cutting or engraving by multiple horizontal lines. For example: when cutting out or engraving a square, the raster setting will make the laser use numerous horizontal lines to fill in the outlined space.

Raster Image – An image that is defined as a collection of arranged pixels in a rectangular array of lines. A raster image is similar to a "Bitmap" graphics image.

Raster Line – A raster line is the individual horizontal line that makes up the raster image.

Serial Port – A connection that allows a computer to send data to a peripheral device one bit at a time. Usually it is a COM port that meets the RS232C specification.

Vector – The process of cutting or engraving an image by using single horizontal, vertical and curved lines. For example: when cutting out or engraving the outline of a square, the vector setting will make the laser use a thin single line to follow the outline of the shape.

10.2 LaserPro Spirit GX Specification Sheet

Spirit GX			
Work Area		34 x 24 in. (860 x 610 mm) Extendable to 38 x 24 in. (965 x 610 mm)	
Maximum Part Size (W x D x Thick)	All doors closed	40 x 24 x 7 in. (1016 x 610 x 177 mm)	
	All doors open	40 x ∞ x 7 in. (1016 x ∞ x 177 mm)	
Table Size		40.3 x 27.7 in. (1025 x 705 mm)	
Dimensions		53.7 x 34.6 x 39.7 in. (1365 x 880 x 1010 mm)	
Laser Source		30 to 100 Watt Sealed CO ₂ Laser	
Cooling		Air-cooled, operating environment temperature 15°- 30° C (60° - 86° F)	
Drive		DC Servo Control	
Maximum Speed*		80 IPS	
Throughput*(SIPH-Square inch per Hour)		260.9 in ² /hr (168 cm ² /hr)	
Throughput* with SmartACT Enabled (SIPH- Square inch per Hour)		322.1 in ² /hr (2078 cm ² /hr)	
Speed Control		Adjustable from 0.1~100% (Up to 16 color-linked speed settings per job)	
Power Control		Adjustable from 0~100% (Up to 16 color-linked power settings per job)	
Z-Axis Movement		Automatic	
Resolution (DPI)		Available 125, 250, 300, 380, 500, 600, 760, 1000,1500,3000	
Computer Interface		Standard printer port and USB port	
Memory Buffer		32MB standard	
Display Panel		4-line LCD panel showing current file name, total working time, laser power, engraving speed, file(s) loaded into memory buffer, setup and diagnostic menus	
Safety		Class 3R for red pointer	
Electrical		Below 40 Watt, 100~240 Volt AC Auto Switching; 40Watt and above, 200~240 Volt AC Auto Switching	
Power Consumption		2000W- 4400W	
Air Exhaust System		External exhaust system required, one 4" connection on the back of the machine.	

*Speed is not equal to throughput. See dealer or visit <http://www.gccworld.com/> for more details

*Caution—Use of controls or adjustments or performance of procedures other than those specified herein may result in hazardous radiation exposure.

* Specifications are subject to change without prior notice.