



Interfacing Guide

Contents:

iFume Range



3

Digital 9000 Range



7

Analogue Range



11

Analogue Multi-Voltage Range



15

PUR35 Range

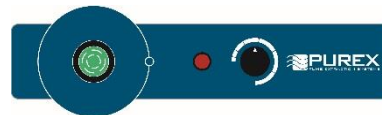

20

iFume Range

105147 – Interface cable no connector

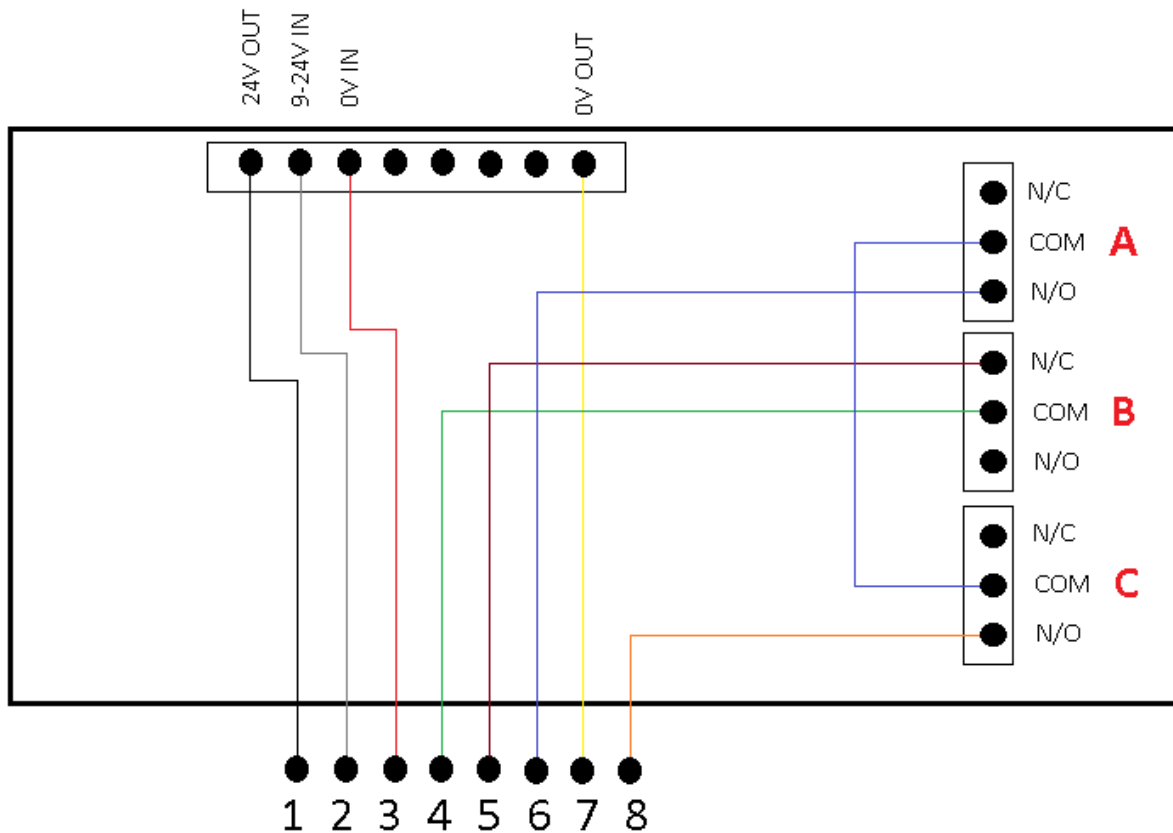

FILTER CONDITION ALARM (Changeable between N/O and N/C in the setup menu)

For instructions on how to change in the setup menu see page 19

N/O (Normally Open)

With the relay condition set to N/O (Normally Open) on the set up menu the relay (B) will remain closed, shorting the connection between the Green wire (Pin 4) and the Brown wire (Pin 5) until the machine gives a filter alarm. When this happens, the contacts on the relay (B) will open breaking the connection between the Green wire (Pin 4) and the Brown wire (Pin 5).

N/C (Normally Closed)

With the relay condition set to N/C (Normally Closed) on the set up menu the relay (B) will remain open breaking the connection between the Green wire (Pin 4) and the Brown wire (Pin 5) until the machine gives a filter alarm. When this happens, the contacts on the relay (B) will close shorting the connection between the Green wire (Pin 4) and the Brown wire (Pin 5).



EXTRACTOR RUN SIGNAL / MOTOR FAIL SIGNAL COMBINED

The relays (A) and (C) are set to Normally Open (not changeable through menu) and are both connected via the common ports. Blue wire (Pin 6) is connected to N/O of relay (A), Orange wire (Pin 8) is connected to N/O of relay (C). When the machine is turned on both relays break the connection between Blue wire (Pin 6) and Orange (Pin 8). When the machine is running the relays (A) and (C) will close shorting the connection between the Blue wire (Pin 6) and the Orange wire (Pin 8). If the "MOTOR FAIL" alerts on screen then the relay (C) will open removing the connection between the Blue wire (Pin 6) and Orange (Pin 8).

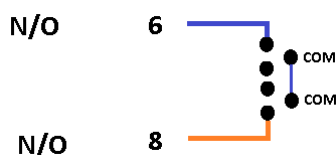

STOP/START

In the iFume range there is a remote start relay, when this relay is given 9-24V the iFume will start remotely. This can be done via external 9-24V or using the internal 24V from the PCB.

Volt Free Start

Connect the Red (Pin 3) "0V in" and Yellow (Pin 7) "0V out". Close the connection from the Black (Pin 1) "24V out", to the White (Pin 2) "24V in" to start the machine. Break the connection between the Black (Pin 1) "24V out" to the White (Pin 2) "24V in" to stop the machine.

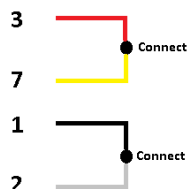

9-24V External Signal Voltage

To start the machine using an external voltage (for example a signal from a laser); Connect the external source (9-24VDC) to the White (Pin 2) "9V-24V in" and the external source (0V) to the Red (Pin 3) "0V in". To stop the machine, disconnect the external voltage (9-24VDC) to the White (Pin 2).

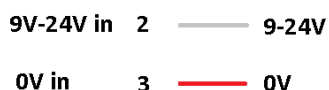

Pin Out Descriptions

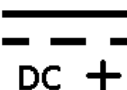
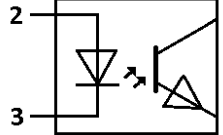
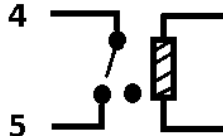
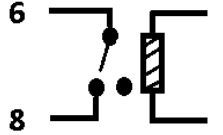
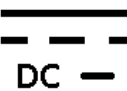
Interface 8 way Female Lumberg		Label	Description
Pin 1		24V out	+24V DC Voltage Source. Do Not Apply Voltage.
Pin 2		9V-24V in	Remote Start opto-isolator. A 9-24V signal across pins 2 and 3 will start the machine.
Pin 3	See picture on Pin 2	0V in	Remote Start opto-isolator. A 9-24V signal across pins 2 and 3 will start the machine.
Pin 4		Alarm Relay (COM)	Alarm contacts between pins 4 and 5 will close/open depending on the software settings, when an alarm is activated.
Pin 5	See picture on Pin 4	Alarm Relay (NO)	Alarm contacts between pins 4 and 5 will close/open depending on the software settings, when an alarm is activated.
Pin 6		Run Signal (COM)	Run Signal contacts between pins 6 and 8 will close when the machine is running.
Pin 7		0V out	0V (GND) Voltage Source. Do Not Apply Voltage.
Pin 8	See picture on Pin 6	Run Signal (NO)	Run Signal contacts between pins 6 and 8 will close when the machine is running.

Connection Examples

Using a 105147 cable the machine can be controlled remotely either volt free, or with a 9-24V signal. Below is an example connection to a host machine. Please **do not apply voltage** to pins 1 and 2 when using the volt free connection type.

Volt Free

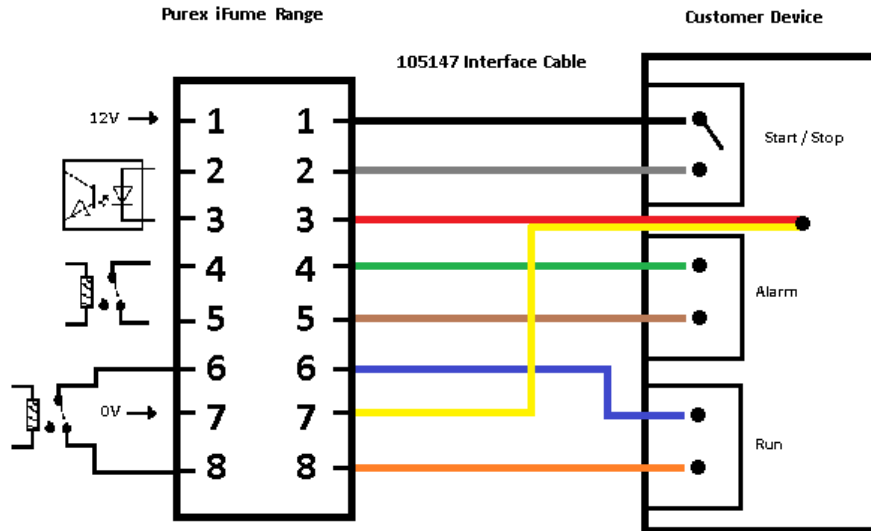

9-24V

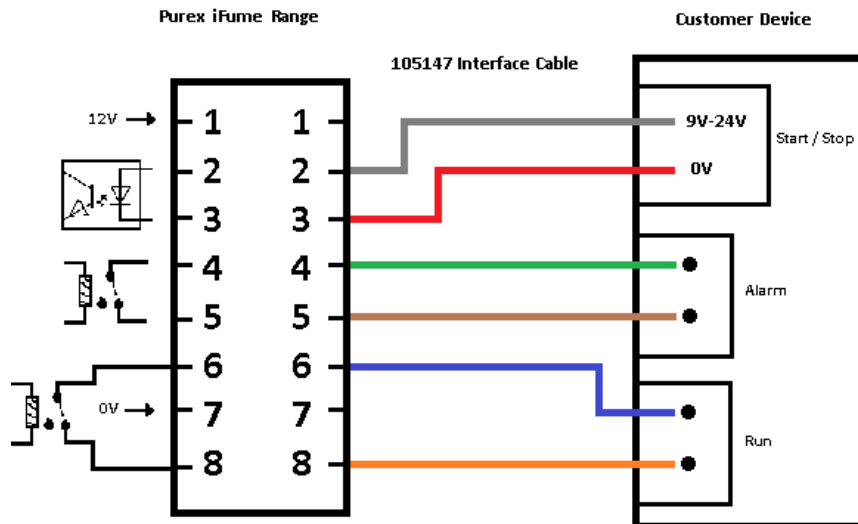

Digital 9000 Range

105108 No Connector – Volt Free Start/Stop

105238 No Connector – 9V-24V Start/Stop

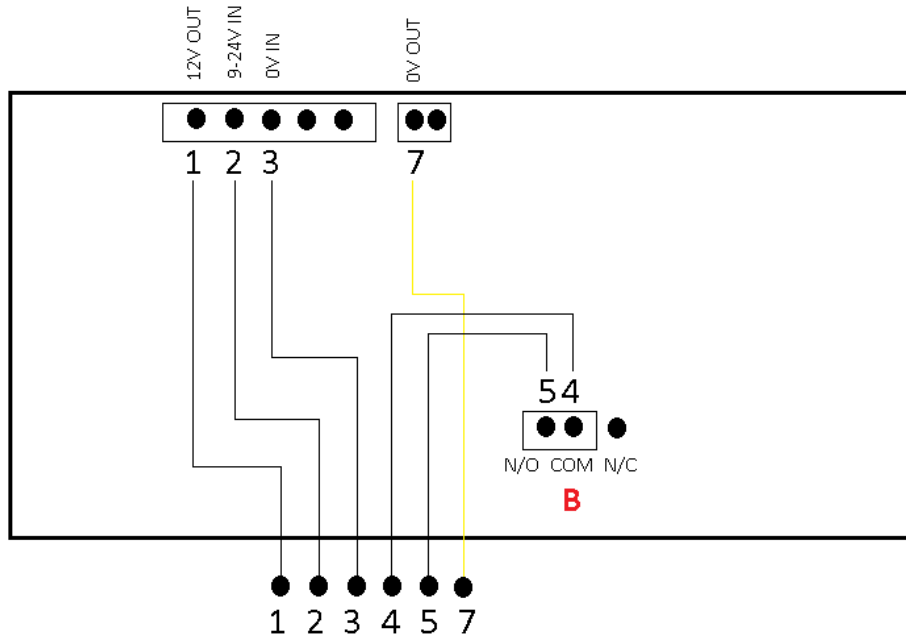

FILTER CONDITION ALARM (Changeable between N/O and N/C in the setup menu)

For instructions on how to change in the setup menu see page 19

N/O (Normally Open)

With the relay condition set to N/O (Normally Open) on the set up menu the relay (B) will remain closed, shorting the connection between the Red wire (Pin 4) and the Blue wire (Pin 5) until the machine gives a filter alarm. When this happens, the contacts on the relay (B) will open breaking the connection between the Red wire (Pin 4) and the Blue wire (Pin 5).

N/C (Normally Closed)

With the relay condition set to N/C (Normally Closed) on the set up menu the relay (B) will remain open breaking the connection between the Red wire (Pin 4) and the Blue wire (Pin 5) until the machine gives a filter alarm. When this happens, the contacts on the relay (D) will close shorting the connection between the Red wire (Pin 4) and the Blue wire (Pin 5).

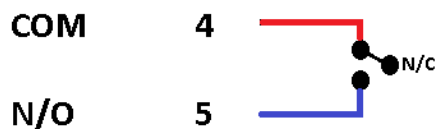

STOP/START

In the 9000 range there is a remote start relay which when activated will start the machine remotely. This can be done via a volt free connection.

Volt Free Start – 105108 Cable

Close the connection from the Yellow (Pin 1) “12V out”, to the Green (Pin 2) “9V-24V in” to start the machine. Break the connection between the Yellow (Pin 1) “12V out” to the Green (Pin 2) “9V-24V in” to stop the machine.

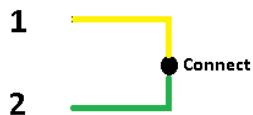

9-24V External Signal Voltage – 105238 Cable

To start the machine using an external voltage (for example a signal from a laser); Connect the external source (9-24VDC) to the Green (Pin 2) “9V-24V in” and the external source (0V) to the Yellow (Pin 3) “0V in”. To stop the machine, disconnect the external voltage (9-24VDC) to the Green (Pin 2).

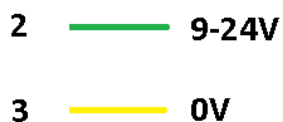

Pin Out Descriptions

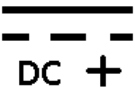
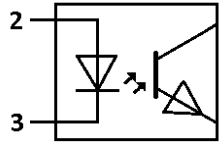
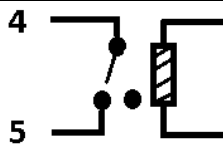
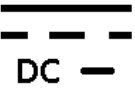
Interface 8 way Female Lumberg		Label	Description
Pin 1		12V out	+12V DC Voltage Source. Do Not Apply Voltage.
Pin 2		9V-24V in	Remote Start opto-isolator. A 9-24V signal across pins 2 and 3 will start the machine.
Pin 3	See picture on Pin 2	0V in	Remote Start opto-isolator. A 9-24V signal across pins 2 and 3 will start the machine.
Pin 4		Alarm Relay (COM)	Alarm contacts between pins 4 and 5 will close/open depending on the software settings, when an alarm is activated.
Pin 5	See picture on Pin 4	Alarm Relay (NO)	Alarm contacts between pins 4 and 5 will close/open depending on the software settings, when an alarm is activated.
Pin 6	Not Used	-	No Functional Use
Pin 7		0V out	0V (GND) Voltage Source. Do Not Apply Voltage.
Pin 8	Not Used	-	No Functional Use

Connection Example

Using a 105108 cable the machine can be controlled remotely volt free. Below is an example connection to a host machine. This connection is volt free, **do not apply voltage**.

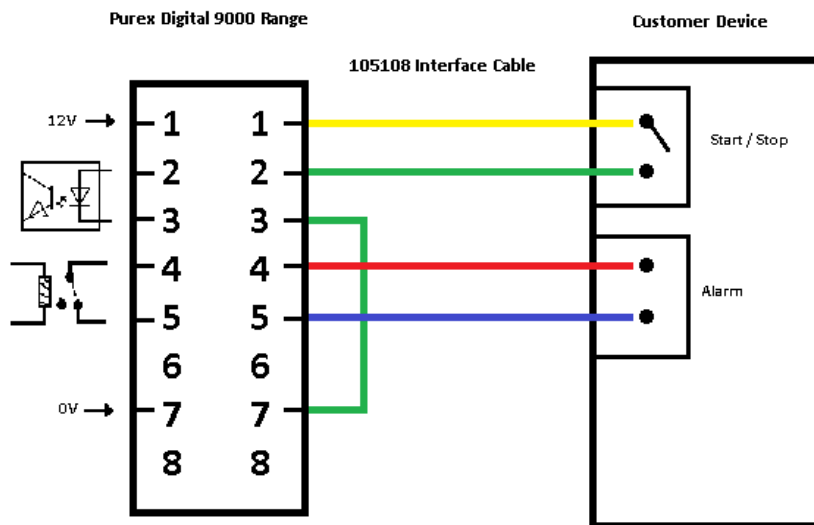

Using a 105238 cable the machine can be controlled remotely with a 9-24V signal. Below is an example connection to a host machine.

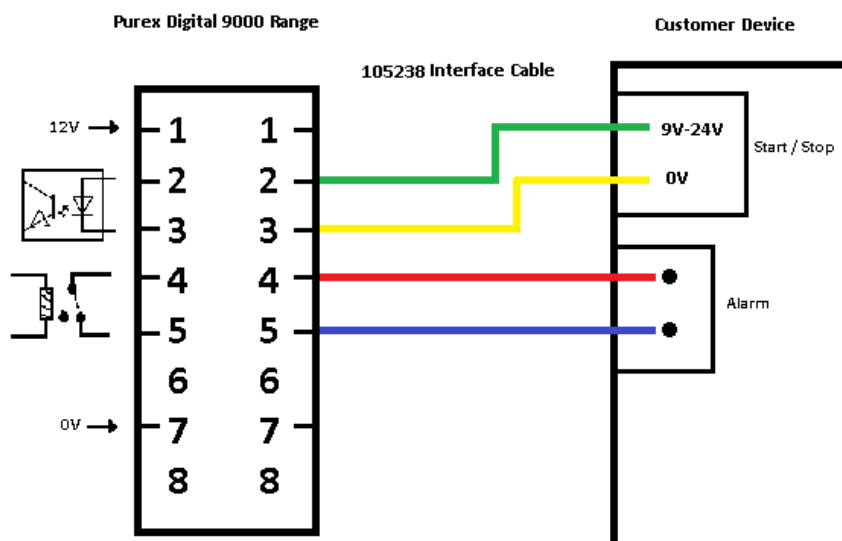

Analogue Range

105108 – Volt Free Start/Stop

105238 – 9V-24V Start/Stop

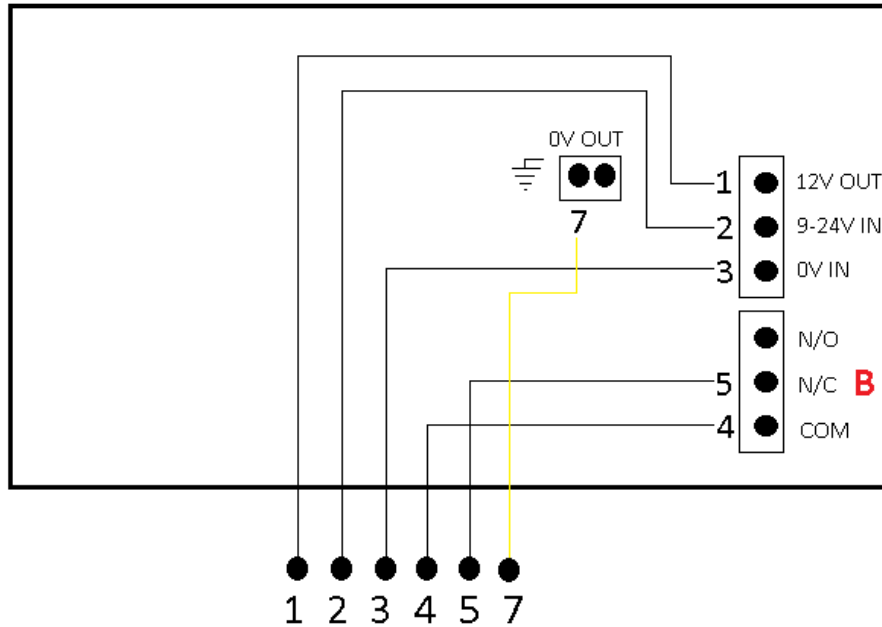

FILTER ALARM

N/C (Normally Closed)

The relay (B) is closed when the machine is on and not alarming, shorting the connection between the Green wire (Pin 4) and the Brown wire (Pin 5). The status changes when the machine gives a filter alarm, when this happens the contacts on the relay (B) will open breaking the connection between the Green wire (Pin 4) and the Brown wire (Pin 5).



STOP/START

In the Analog range there is a remote start relay which when activated will start the machine remotely, using the switch on the rear of the machine will allow the user to switch between using the interface to start or use as a standalone machine. Selecting the "1" position allows the user to use the interface socket to start the machine.

Volt Free Start – 105108 Cable

Close the connection from the Yellow (Pin 1) "12V out", to the Green (Pin 2) "9V-24V in" to start the machine. Break the connection between the Yellow (Pin 1) "12V out" to the Green (Pin 2) "9V-24V in" to stop the machine.

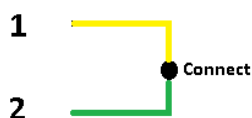

9-24V External Signal Voltage – 105238 Cable

To start the machine using an external voltage (for example a signal from a laser); Connect the external source (9-24VDC) to the Green (Pin 2) "9V-24V in" and the external source (0V) to the Yellow (Pin 3) "0V in". To stop the machine, disconnect the external voltage (9-24VDC) to the Green (Pin 2).

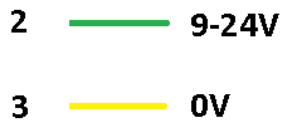

Pin Out Descriptions

Using the Interface switch on the back of the machine the user can swap from using the machine as a standalone machine to being controlled by an external device, such as laser or wave solder. Simply switch to the "1" position to control the stop start function via interfacing.

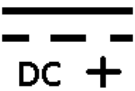
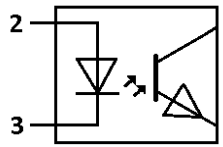
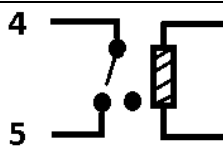
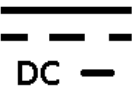
Interface 8 way Female Lumberg		Label	Description
Pin 1		12V out	+12V DC Voltage Source. Do Not Apply Voltage.
Pin 2		9V-24V in	Remote Start opto-isolator. A 9-24V signal across pins 2 and 3 will start the machine.
Pin 3	See picture on Pin 2	0V in	Remote Start opto-isolator. A 9-24V signal across pins 2 and 3 will start the machine.
Pin 4		Alarm Relay (COM)	Alarm contacts between pins 4 and 5 will close/open depending on the software settings, when an alarm is activated.
Pin 5	See picture on Pin 4	Alarm Relay (NO)	Alarm contacts between pins 4 and 5 will close/open depending on the software settings, when an alarm is activated.
Pin 6	Not Used	-	No Functional Use
Pin 7		0V out	0V (GND) Voltage Source. Do Not Apply Voltage.
Pin 8	Not Used	-	No Functional Use

Connection Example

Using a 105108 cable the machine can be controlled remotely volt free. Below is an example connection to a host machine. This connection is volt free, **do not apply voltage**.

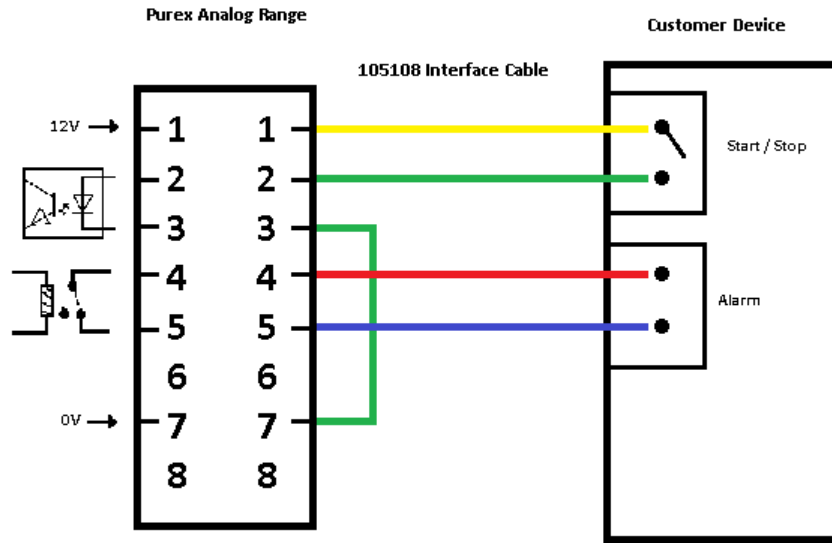

Using a 105238 cable the machine can be controlled remotely with a 9-24V signal. Below is an example connection to a host machine.

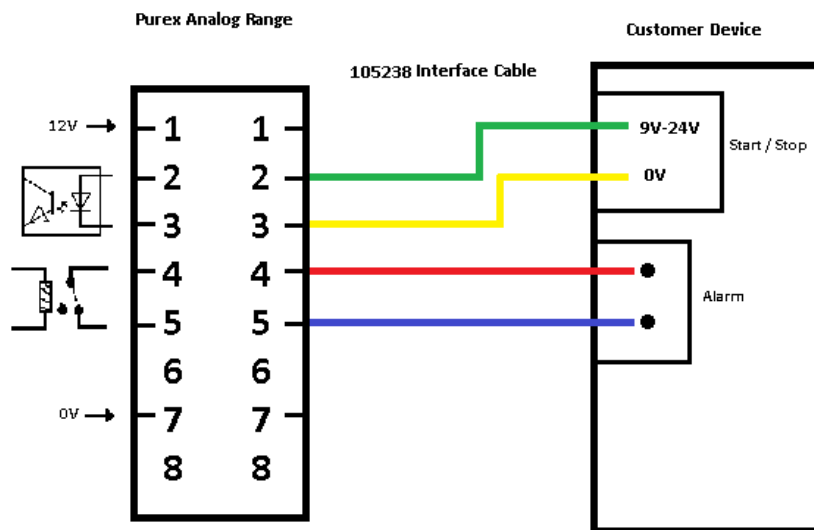

Analogue Multi-Voltage Range

105146 – Interface cable no connector

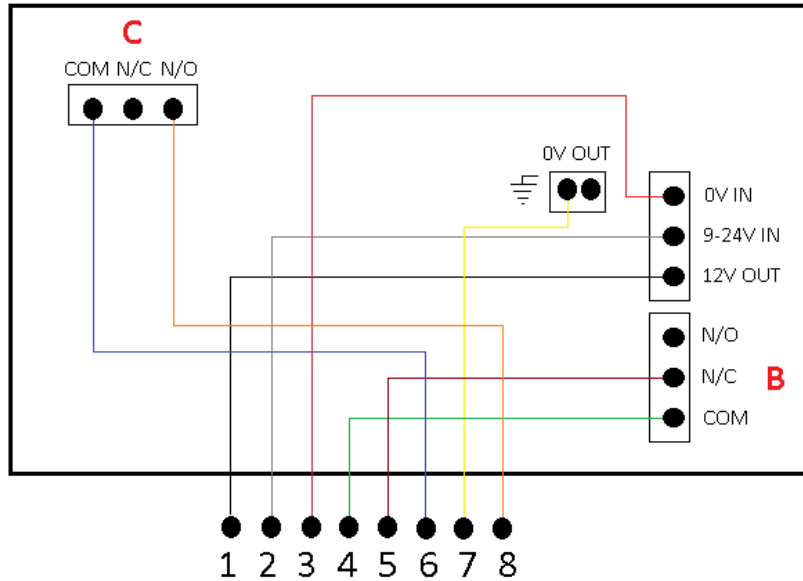

FILTER ALARM

N/C (Normally Closed)

The relay (B) is closed when the machine is on and not alarming, shorting the connection between the Green wire (Pin 4) and the Brown wire (Pin 5). The status changes when the machine gives a filter alarm, when this happens the contacts on the relay (B) will open breaking the connection between the Green wire (Pin 4) and the Brown wire (Pin 5).



EXTRACTOR RUN SIGNAL

The relay (C) is set to Normally Open (not changeable through menu) opening the connection between Blue wire (Pin 6) and Orange (Pin 8). When the machine is running the relay (C) will close shorting the connection between the Blue wire (Pin 6) and the Orange wire (Pin 8).

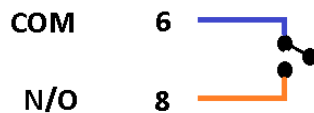

STOP/START

In the Analog range multi-voltage range there is a remote start relay which when activated will start the machine remotely. Using the switch on the rear of the machine will allow the user to switch between using the interface to start or use as a standalone machine. Selecting the "1" position allows the user to use the interface socket to start the machine.

Volt Free Start

Using the 105146 cable the Red (Pin 3) "0V in" and Yellow (Pin 7) "0V out" are already shorted together. Close the connection from the Black (Pin 1) "12V out", to the White (Pin 2) "9V-24V in" to start the machine. Break the connection between the Black (Pin 1) "12V out" to the White (Pin 2) "9V-24V in" to stop the machine.

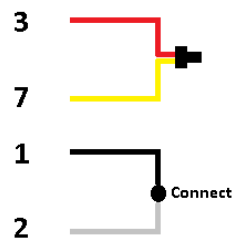

Pin Out Descriptions

Using the Interface switch on the back of the machine the user can swap from using the machine as a standalone machine to being controlled by an external device, such as laser or wave solder. Simply switch to the "1" position to control the stop start function via interfacing.

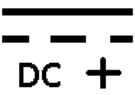
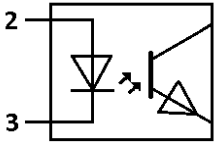
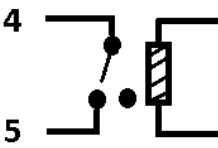
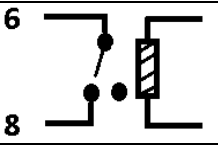
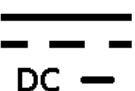
Interface 8 way Female Lumberg		Label	Description
Pin 1		12V out	+12V DC Voltage Source. Do Not Apply Voltage.
Pin 2		9V-24V in	Remote Start opto-isolator. A 9-24V signal across pins 2 and 3 will start the machine.
Pin 3	See picture on Pin 2	0V in	Remote Start opto-isolator. A 9-24V signal across pins 2 and 3 will start the machine.
Pin 4		Alarm Relay (COM)	Alarm contacts between pins 4 and 5 will close/open depending on the software settings, when an alarm is activated.
Pin 5	See picture on Pin 4	Alarm Relay (NO)	Alarm contacts between pins 4 and 5 will close/open depending on the software settings, when an alarm is activated.
Pin 6		Run Signal (COM)	Run Signal contacts between pins 6 and 8 will close when the machine is running.
Pin 7		0V out	0V (GND) Voltage Source. Do Not Apply Voltage.
Pin 8	See picture on Pin 6	Run Signal (NO)	Run Signal contacts between pins 6 and 8 will close when the machine is running.

Connection Examples

Using a 105146 cable the machine can be controlled remotely volt free. Below is an example connection to a host machine. This connection is volt free, do not apply voltage.

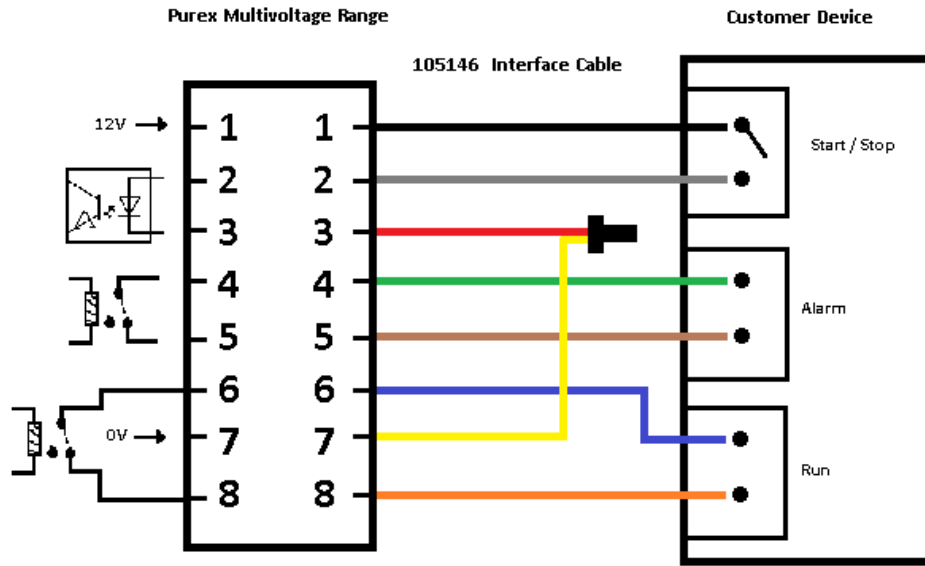

PUR 35 Range

105108 No Connector – Volt Free Start/Stop

105238 No Connector – 12V Start/Stop

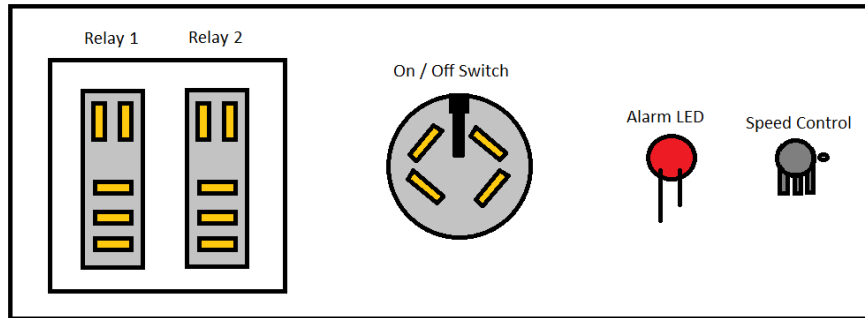

View from inside the electrical compartment

FILTER CONDITION ALARM (Relay 1)

N/O (Normally Open)

When the machine starts and there are no alarms the relay (1) will remain open, until the machine gives a filter alarm. When this happens, the contacts on the relay (1) will close making the connection between the Red wire (Pin 4) and the Blue wire (Pin 5).

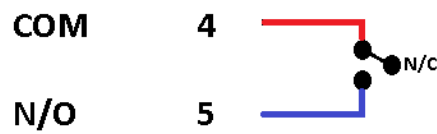

STOP/START (Relay 2)

In the PUR 35 range there is a remote start relay (2) which when activated will start the machine remotely. This can either be done via a volt free connection, or a 12V signal.

Volt Free Start – example 105108 Cable

Close the connection from the Yellow (Pin 1) “12V out”, to the Green (Pin 2) “12V in” to start the machine. Break the connection between the Yellow (Pin 1) “12V out” to the Green (Pin 2) “12V in” to stop the machine.

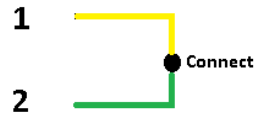

12V External Signal Voltage – example 105238 Cable

To start the machine using an external voltage (for example a signal from a laser); Connect the external source (12VDC) to the Green (Pin 2) “12V in” and the external source (0V) to the Yellow (Pin 3) “0V in”. To stop the machine, disconnect the external voltage (12VDC) to the Green (Pin 2).

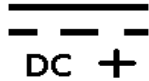
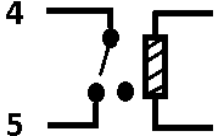

Pin Out Descriptions

Interface 8 way Female Lumberg		Label	Description
Pin 1		12V out	+12V DC Voltage Source. Do Not Apply Voltage.
Pin 2	Relay (2) +ve	12V in	Remote Start relay (2). A 12V signal across pins 2 and 3 will start the machine.
Pin 3	Relay (2) -ve	0V in	Remote Start relay (2). A 12V signal across pins 2 and 3 will start the machine.
Pin 4		Alarm Relay (COM)	Alarm relay (1) contacts between pins 4 and 5 will close when an alarm is activated.
Pin 5	See picture on Pin 4	Alarm Relay (NO)	Alarm relay (1) contacts between pins 4 and 5 will close when an alarm is activated.
Pin 6	Not Used	-	No Functional Use
Pin 7	Not Used	-	No Functional Use
Pin 8	Not Used	-	No Functional Use

Connection Example

Using a 105108 cable the machine can be controlled remotely volt free. Below is an example connection to a host machine. This connection is volt free, **do not apply voltage**.

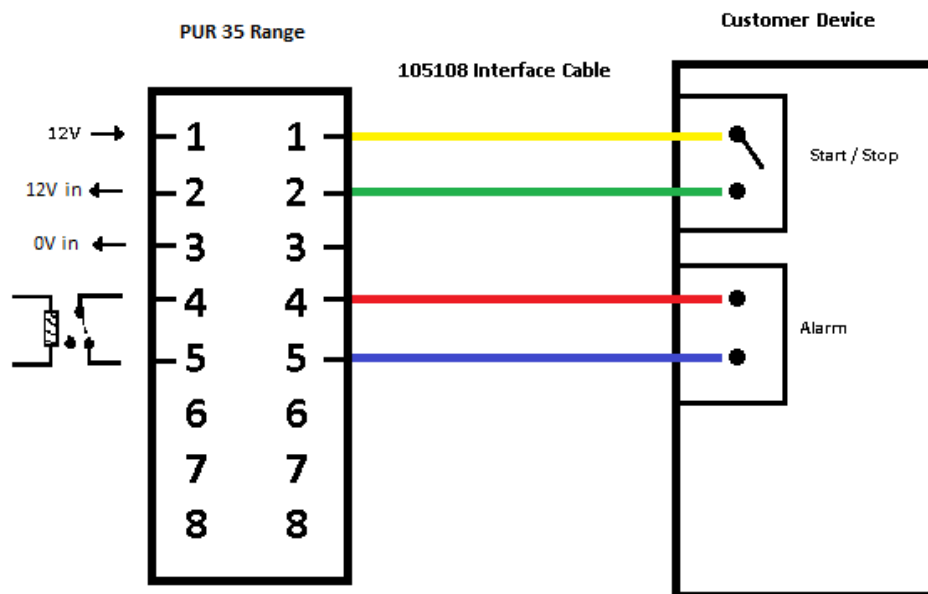

Using a 105238 cable the machine can be controlled remotely with a 12V signal. Below is an example connection to a host machine.

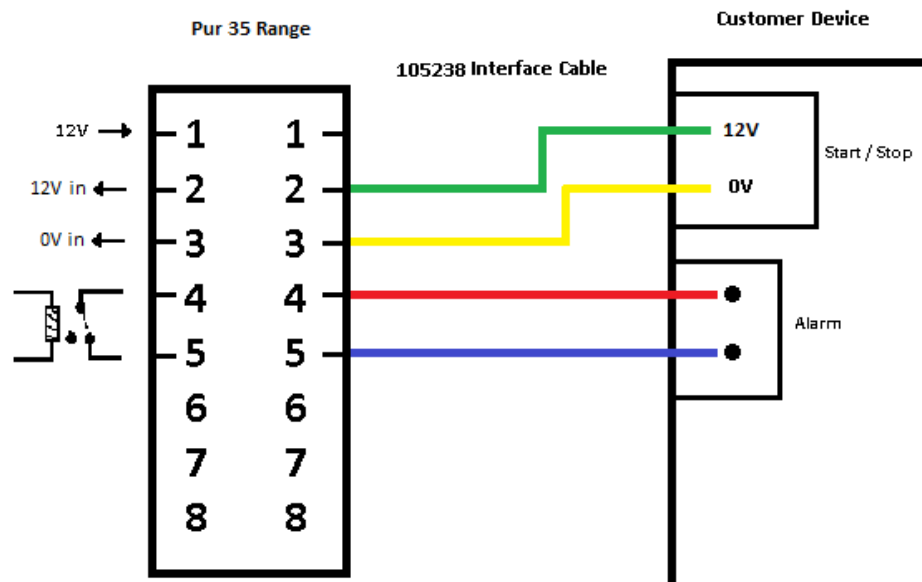

Setting the Alarm Relay Condition – iFume Range

Starting at the front home screen;

1. Press “Support”.
2. Press “Setup”.
3. Enter the Passcode = “2603”.
4. Press “Enter”.
5. Press “Alarm NO” until it changes to “Alarm NC”, (or vice versa)
6. Then press back to return to the home screen

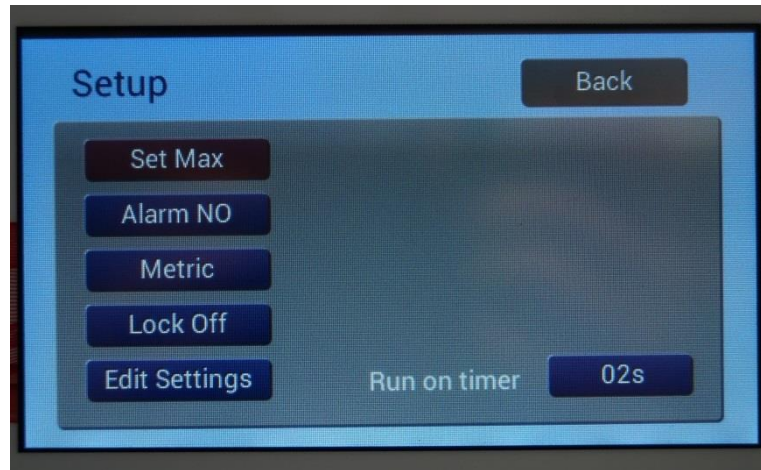

Setting the Alarm Relay Condition – 9000 Range

Starting at the front home screen;

1. Press the “left” and “right keys” together once.
2. Press down twice until “Engineer PWD = 498”.
3. Press “right key” once.
4. Press “Down Key” 5 times until “Filter Cond Rly N/O” is highlighted.
5. Press “left or Right Key” to change selection from NO to NC.
6. Press “Up Key” 6 times to exit the menu to the front home screen.



Interface Cables with Connectors Attached

Code	Plug or socket type	Functions	Pins	Picture
105103	6 Way, Bulgin, Male, Plug	Volt Free Alarm 9V-24V Start/Stop 0V	1 + 4 3 5	
105104	9 Way, D Type, Male, Plug	Volt Free Alarm Volt Free Start/Stop	1 + 2 3 + 4	
105106	9 Way, D Type, Female, Socket	No Alarm Output 9V-24V Start/Stop 0V	- 5 2	
105107	9 Way, D Type, Male, Plug	9V-24V Alarm 9V-24V Start/Stop 0V	3 1 9	

105096

6 Way, Lumberg,
Female, Socket

Volt Free Alarm
9V-24V Start/Stop
0V

1/3 + 4/6
5
2



105097

4 Way, Mini Bulgin,
Male, Plug

Volt Free Alarm
Volt Free Start/Stop

1 + 2
3 + 4



105098

6 Way, Lumberg,
Male, Plug

Volt Free Alarm
9V-24V Start/Stop
0V

3 + 4
1
2



105105

5 Way, XLR Neutric,
Female, Plug

9V-24V Alarm
9V-24V Start/Stop
0V

4
2/3
5



105114 Remote Foot Switch Foot Switch N/A



105130 Remote On/Off Switch Box On/Off Switch N/A



For any other interface requirements please contact support.



Jorlink USA, Inc, 3714

Alliance Dr., Suite 100

Greensboro, NC 27407

sales@jorlink.com

sales@fumefiltration.com

Tel (336) 288-1613